



**Flanders
Scientific
Inc.**

Monitor User Manual

Updated 12.16.2021

BM Series

BM090

BM210

BM211

BM230

BM240

BM241

CM Series

CM171

CM172

CM240

CM250

CM320TD

CM420TD

CM500TD

This manual is based on firmware version 1.1.04-2249 for most models, version 2.0.00-2309 or later for BM211 and BM241. If you have an older or newer firmware version some of the functions mentioned in this manual may not be present or may operate differently.

Flanders Scientific, Inc.

6215 Shiloh Crossing

Suite G

Alpharetta, GA. 30005

Phone: +1.678.835.4934

Fax: +1.678.804.1882

E-Mail: Support@FlandersScientific.com

www.FlandersScientific.com

TOPIC	PAGE(S)
Safety Precautions	3-4
Parts & Their Functions	5-6
Menu Navigation / System Status	7
Function Menu	8-19
Scopes & Audio Meters Menu	20-22
Video Menu	23-25
Audio Menu	26
Marker Menu	27
Alarm Menu	28-29
OSD Menu	30
GPI Menu	31
Color Management menu	32-34
System Menu	35-36
Troubleshooting Guide	37-38
Appendix A - DIT LUTs	39-40
Appendix B - Calibration LUTs	41-42
Appendix C - Ethernet Connectivity	43

Connecting and Disconnecting SDI BNC Cables

To prevent damage to components from electrical discharge follow these steps:

- Connect power first on all devices.
- Power on all devices.
- Connect BNC cables.

To disconnect:

- Disconnect BNC cables.
- Power down and disconnect power from devices.

If using a wireless video receiver we strongly suggest using an SDI Video Ground Path Isolator (available at ShopFSI.com and ShopFSI.eu) and powering the receiver from a separate power source than the monitor. Use of wireless video receivers can cause dangerous ground loop issues that can damage connected equipment like monitors. Using a ground loop isolator **AND** powering from a separate power source will help keep downstream equipment protected.

Safety Precautions

- All operating instructions must be read and understood before the product is operated.
- These safety and operating instructions must be kept in a safe place for future reference.
- All warnings on the product and in the instructions must be observed closely.
- All operating instructions must be followed.
- Do not use attachments or accessories not recommended by the manufacturer. Use of inadequate attachments may result in serious accidents.
- Do not place heavy objects on the power cord. Route power cord to prevent people from stepping on or resting objects on the cord. Check to ensure that both outlet and product connection points are properly seated and secured.
- This product must be operated on a power source as specified on the specification label or product screening. Always operate the product within the voltage range specified.
- Do not overload AC outlets or extension cords. Overloading can cause fire or serious electric shock.
- Never insert an object into the product through vents or openings as this can cause serious electric shock or damage.
- Do not expose product to water or other liquids as this can lead to electrical shock or permanent damage.
- Do not attempt to service the product yourself. Removing covers can expose you to high voltage and other unsafe conditions. Please seek the assistance of a qualified service professional for all service needs.
- If any of the following occur, unplug the power cord from the AC outlet and consult a qualified service professional to perform repairs:
 - Power cord or plug becomes damaged.
 - When any liquid is spilled on or in the product.
 - When the product has been exposed to rain or water.
 - When the product does not operate properly as described in the instruction manual.
 - When the product has been dropped or damaged.
- If the product requires replacement parts, make sure that the service person uses replacement parts specified by the manufacturer, or those equivalent parts having the same characteristics and performance specifications as the original parts. Use of unauthorized parts can result in fire, electric shock, and/or other damage.

- Upon completion of any service or repair work, request that the service technician perform safety checks to ensure that the product is in proper working order.
- When mounting the product to a wall, ceiling, or within a rack/enclosure, be sure to install the product according to the instructions of both the mount and monitor manufacturer.
- Unplug the power cord from the AC outlet before cleaning the product.
- For proper screen maintenance please follow the guidelines below to prevent scratches, discoloration, or other damage to the panel:
 - Avoid striking the screen with any object.
 - Do not wipe screen hard. Apply only gentle pressure if cleaning.
 - Do not wipe the screen with solvents such as alcohol, paint thinner, or benzene as this can cause permanent damage to the panel.
 - Do not spray detergent or other cleaners directly on the monitor or panel.
 - Do not write on the panel with any substance or object.
 - Do not paste or stick anything to the screen as any adhesive can cause damage to the panel.
 - Screen may be cleaned by gently wiping with lint free cloth to remove dust. For more thorough cleaning use a lint free cloth that has been very lightly dampened with distilled water. Please dry any excess moisture from the monitor or panel immediately to prevent damage.
- Take care in moving this product as serious injury or death can result from the sudden shifting or falling of this object.
- The vents and openings in the product's chassis are designed for ventilation. Do not cover, block, or otherwise obstruct these vents and openings as insufficient ventilation can cause overheating and/or shorten the life of the product. Do not place the object on a bed, sofa, rug, or other similar surface as this can result in serious obstruction of ventilation areas. If using in enclosed space make sure to provide proper ventilation to maintain allowable operating temperature range.
- The panel used in this product contains glass and can cause serious injury if broken. If the unit is dropped or otherwise damaged take care to avoid possible injury by glass shards.
- For proper chassis maintenance please follow the guidelines below to avoid any potential damage:
 - Do not wipe the chassis with solvents such as alcohol, paint thinner, or benzene.
 - Do not expose the cabinet to any volatile substances.
 - Do not allow prolonged contact with rubber or plastic.
 - Apply only gentle pressure to chassis when cleaning.
 - To clean use soft, lint free cloth to remove dust. A lightly dampened cloth, as described in the screen maintenance section, may also be used to clean the chassis.
- Keep this product away from heat generating sources such as radiators, heaters, stoves, or other heat generating products.
- Avoid prolonged exposure to direct sunlight as this can cause damage to the panel

FCC (Federal Communications Commission)

This equipment has been tested and found to comply with the limits for a class A digital device, pursuant to part 15 of the FCC Rules. These limits are designed to provide reasonable protection against harmful interference when the equipment is operated in a commercial environment.

This equipment generates, uses, and can radiate radio frequency energy, and if not installed and used in accordance with the instruction manual, may cause harmful interference to radio communications.

Warning: Changes or modifications not expressly approved by the manufacturer responsible for compliance void the user's authority to operate the equipment.

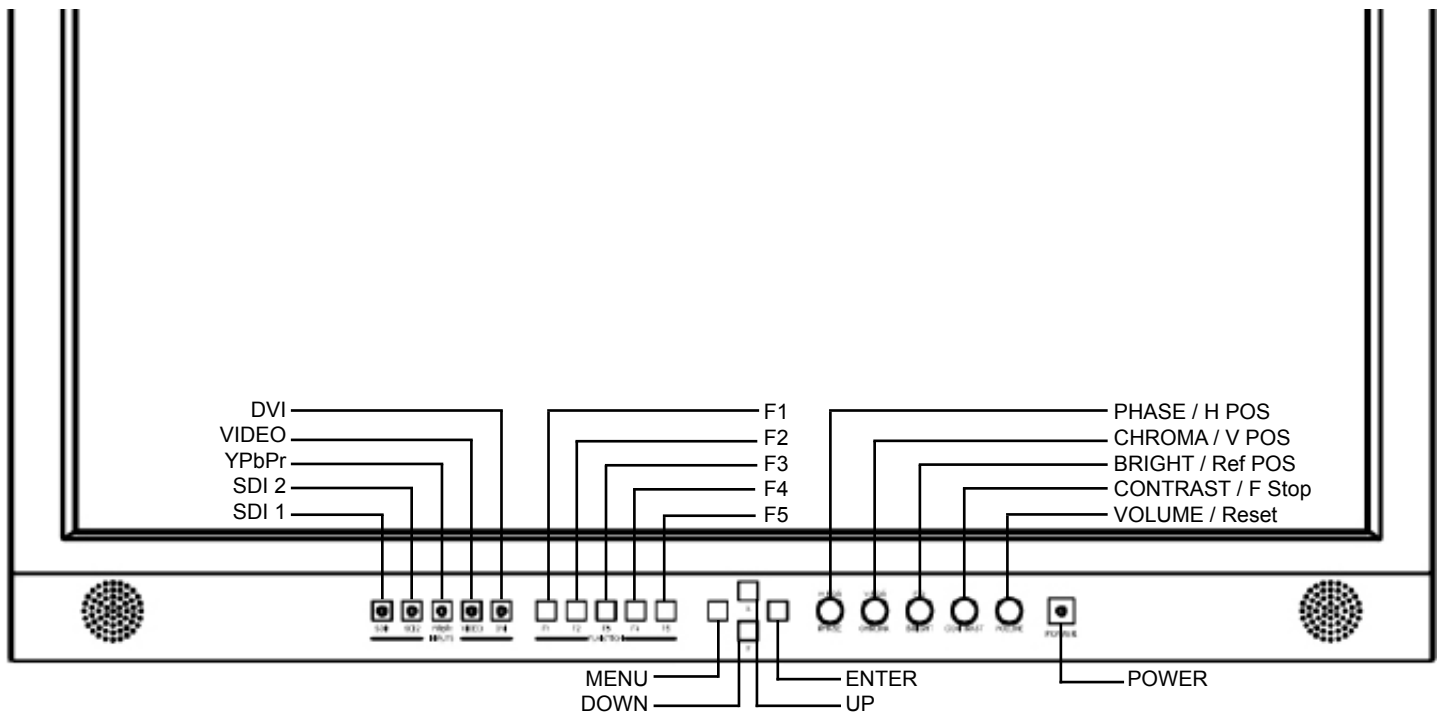

- **SDI 1:** Used to select SDI Input 1 as the active Input.
- **SDI 2:** Used to select SDI Input 2 as the active Input.
- **YPbPr:** Used to select the Component Analog Input as the active Input.
- **VIDEO:** Used to select the Composite Analog Input as the active Input.
- **DVI:** Used to select the DVI-I Input as the active Input. DVI-Digital / DVI-Analog toggle is available in the Video Menu (Menu/Video/DVI Selection).
- **F1:** Assignable function key. This key's function is selectable from the Function Menu.
- **F2:** Assignable function key. This key's function is selectable from the Function Menu.
- **F3:** Assignable function key. This key's function is selectable from the Function Menu.
- **F4:** Assignable function key. This key's function is selectable from the Function Menu.
- **F5:** Assignable function key. This key's function is selectable from the Function Menu.
- **MENU:** Used to enable On Screen Menu.
- **UP:** Used in combination with DOWN and ENTER Keys to navigate On Screen Menu.
- **DOWN:** Used in combination with UP and ENTER Keys to navigate On Screen Menu.
- **ENTER:** Used in combination with UP and DOWN Keys to navigate On Screen Menu. The ENTER button is used to confirm selections within the On Screen Menu.
- **POWER:** Used to turn power on/off.
- **VOLUME:** Used to adjust volume. Press down on this knob to instantly mute or unmute the volume.
- **CONTRAST:** Used to adjust contrast higher or lower. Pressing down on the center of this button will return the contrast setting to its default position. The contrast knob should NOT be used to increase the overall display luminance.
- **BRIGHT / F.D. / Ref POS:** Used to adjust brightness higher or lower. Pressing down on the center of this button will return the brightness setting to its default position. The brightness knob is a low-level offset, it is not used to change display peak luminance. Use the Luminance setting on the System Menu to adjust overall luminance.
- **CHROMA / V POS:** Used to adjust chroma higher or lower. Pressing down on the center of this button will return the chroma setting to its default position.
- **PHASE / H POS:** Used to adjust phase. Pressing down on the center of this button will return the setting to default. Hue is locked by default on SDI, but can be unlocked by the SDI Hue Adjustment option on the System Menu.
- **Tally:** Three color tally lamp controlled via remote control.

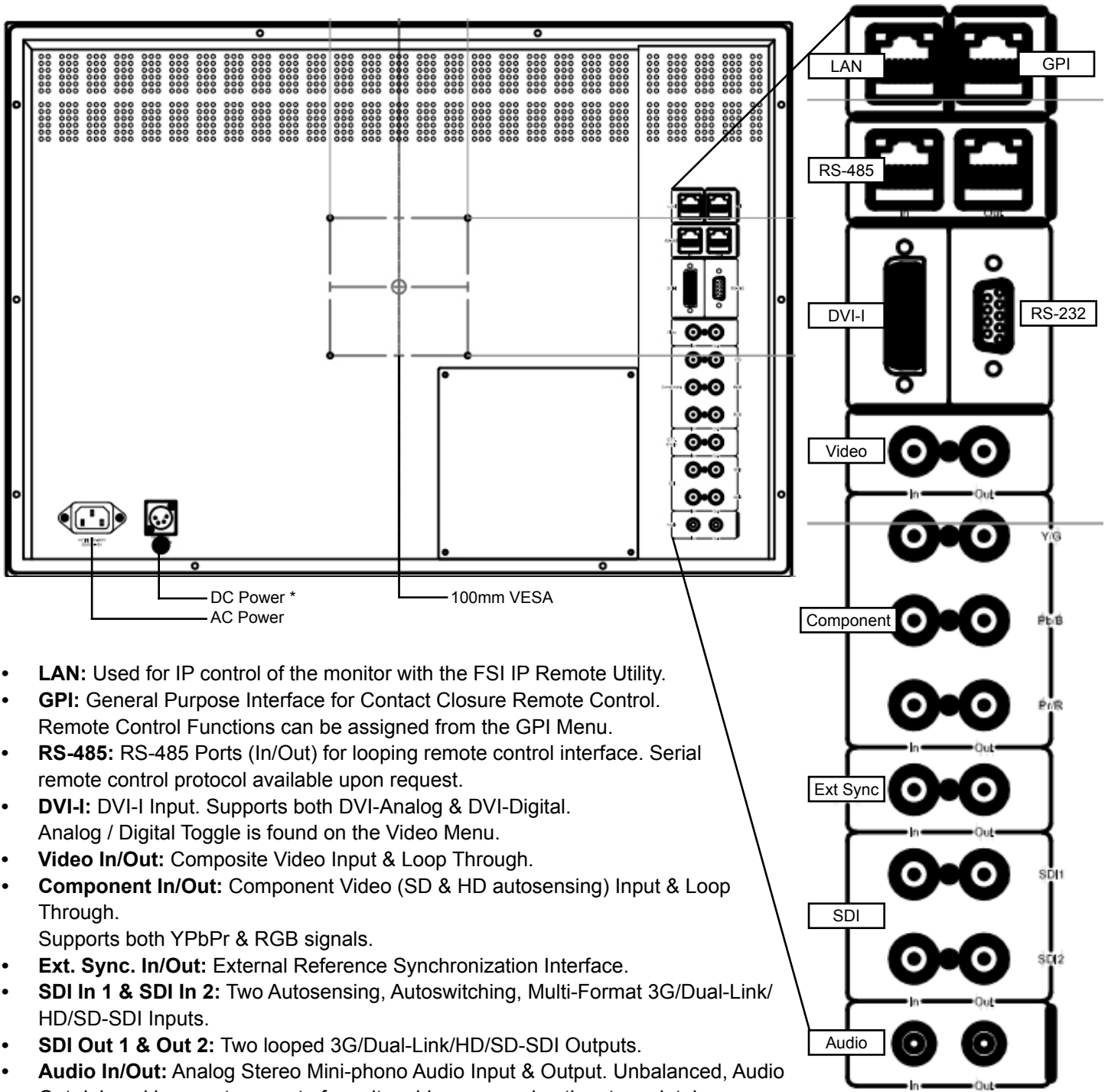

- **LAN:** Used for IP control of the monitor with the FSI IP Remote Utility.
- **GPI:** General Purpose Interface for Contact Closure Remote Control. Remote Control Functions can be assigned from the GPI Menu.
- **RS-485:** RS-485 Ports (In/Out) for looping remote control interface. Serial remote control protocol available upon request.
- **DVI-I:** DVI-I Input. Supports both DVI-Analog & DVI-Digital. Analog / Digital Toggle is found on the Video Menu.
- **Video In/Out:** Composite Video Input & Loop Through.
- **Component In/Out:** Component Video (SD & HD autosensing) Input & Loop Through. Supports both YPbPr & RGB signals.
- **Ext. Sync. In/Out:** External Reference Synchronization Interface.
- **SDI In 1 & SDI In 2:** Two Autosensing, Autoswitching, Multi-Format 3G/Dual-Link/HD/SD-SDI Inputs.
- **SDI Out 1 & Out 2:** Two looped 3G/Dual-Link/HD/SD-SDI Outputs.
- **Audio In/Out:** Analog Stereo Mini-phono Audio Input & Output. Unbalanced, Audio Out delayed by exact amount of monitor video processing time to maintain sync.

*** Note: CM250 models starting at M250A00845 and newer feature an auto-ranging 12~24 VDC connection. All BM211 and BM241 feature auto-ranging 12V~24VDC support.**

Main Menu

Pressing the MENU button on the monitor's keypad will call up the On Screen Menu, as shown below:

Main Menu	Function	
Function	F1	Scopes & Audio Meters 1
Scopes & Audio Meters	F2	Scopes & Audio Meters 2
Video	F3	Scopes & Audio Meters 3
Audio	F4	Marker 1
Marker	F5	Measurement (10Bit)
Alarm	Function Display	On
OSD		
GPI		
Color Management		
System		
System Status		
Support		

Navigating the Main Menu

To navigate the Main Menu simply use the UP and DOWN keys to highlight a category and press the ENTER button to select the highlighted sub menu. Navigate the sub menu in the same way by using the UP and DOWN keys to highlight a particular function and press ENTER to toggle between that function's settings. To exit the menu or back out of a sub menu simply press the MENU button.

System Status

The System Status menu does not contain any configurable settings but does provide important information regarding your monitor's serial number, firmware version, & current configuration.

Main Menu	System Status	
Function	Input	SDI 1
Scopes & Audio Meters	Video Format	1080p 60hz
Video	PAP Input	SDI 2
Audio	Video Format	No Signal
Marker	Volume	16
Alarm	Contrast	0
OSD	Brightness	0
GPI	Chroma	0
Color Management	Hue	0
System	Model	CM250-3G
System Status	S/N	M250A00000
Support	System Version	1.1.03-2144

Pressing an input button will temporarily call up a secondary system status summary window that will indicate incoming signal resolution and frame rate, active color space selected on Color Management menu, gamma response selected on Video Menu, & color matching function selected on Color Management Menu*.

*Color Matching Function toggle only works on OLED units, all other units currently use CIE 1931 CMF only.

Main Menu	Function	
Function	F1	Scopes & Audio Meters 1
Scopes & Audio Meters	F2	Scopes & Audio Meters 2
Video	F3	Scopes & Audio Meters 3
Audio	F4	Marker
Marker	F5	Measurement (10Bit)
Alarm	Function Display	Off
OSD		
GPI		
Color Management		
System		
System Status		
Support		

WARNING: Changing a function button assignment does NOT automatically turn an active function off. Make sure to disable unwanted active functions before changing function button assignments.

NOTE: Many features (Waveform, Vector Scope, Audio Level Meters, etc.) require a function key in order to operate. Some menus (such as the Scopes & Audio Meters Menu) only set your display preferences while a corresponding function key must be assigned to turn the feature on and off. If you are having trouble with a monitor feature make sure you have assigned the proper function key and any corresponding menu settings.

The Function Menu allows you to assign user selectable functions to any of the 5 function buttons (F1, F2, F3, F4, & F5) on the monitor keypad. Some monitor features listed as assignable options in the function menu are also selectable via the embedded menus and are present simply to provide an option for faster, single button press access to the desired function. Other features listed require a function key for activation, but may have associated customizable settings that can be found in other menus.

Assigning Function Keys

To assign a function to a function key highlight one of the 5 Function lines and press ENTER. A list of assignable functions will appear. Select the desired function with the UP and DOWN buttons and press ENTER to assign that function to the corresponding function key. The Function Display option at the bottom of the Function Menu gives you the option to have a temporary confirmation window appear on screen after a function key is pressed that will identify the function that was turned on or off.

Scopes & Audio Meters 1, 2, 3

These functions toggle on/off a Scopes & Audio Meters profile. Three profile slots are available from the Scopes & Audio Meters Menu and each profile can be set to a specific function key allowing you to instantly toggle between various types of Scope and/or Audio Level Meter configurations. Please note that if you have set both Scopes Windows to the Off position in the Scopes & Audio Meters menu the luminance scope will appear when toggled.

Cross Hatch

Toggles on/off the onscreen display of a graphical cross hatch overlay.

Marker 1, 2, 3

These functions activate the onscreen display of the preset Area, Safety, Custom Graticules, or Active Boundary Markers as set in the Marker Profiles. Marker Profiles can be customized via the Marker Menu. By utilizing this function you can toggle on/off your selected markers with a single function key (see [Marker Menu](#) section of this manual for more details).

Overscan

The Overscan function can work with 1:1 Pixel mapping mode on or off. With 1:1 Pixel to Pixel mapping mode turned off the Overscanned image is scaled full screen. With 1:1 Pixel to Pixel mapping mode turned on the image remains unscaled, but the area lying outside of the active scan area is blacked out. This area represents the same area not visible with Pixel to Pixel mode off.

Mono Mode

Activates the Monochrome function. Press once to turn on and again to turn off. In addition to the standard monochrome mode the monitor also features the ability to see the red, green, or blue channel only as monochrome. See Blue/Red/Green Only section for details.

Details on Overscan Function

With the overscan function off all active lines of video can be displayed on screen. With overscan on a small percentage of the outermost active video will not be displayed. Additionally, the monitor can scale the overscanned video full screen or 'blackout' the outlying area while maintaining a pixel to pixel display of the video inside the active scan area. To toggle between these variations of Overscan use the 1:1 Pixel to Pixel mapping function. With both Pixel to Pixel mapping and Overscan selected the area outside of the active scan will simply be blacked out, but the active video will not be scaled outside of the 1:1 pixel scan. With Pixel to Pixel mapping off and overscan on the active scan area will be scaled full screen. To view all active lines in Pixel to Pixel mapping mode make sure to turn Overscan off.

Overscan Examples

(Images represent 720p source on BM241)

Pixel to Pixel Off
Overscan Off



Pixel to Pixel On
Overscan On



Pixel to Pixel Off
Overscan On



Pixel to Pixel On
Overscan Off



More Overscan Examples

(Images represent 1080i source on BM230)

Pixel to Pixel Off
Overscan Off



Pixel to Pixel On
Overscan On



Pixel to Pixel Off
Overscan On



Pixel to Pixel On
Overscan Off



Sub Window

Largely deprecated for use on CFE2 equipped units. For side by side viewing on CFE2 units please use the dedicated [PAP function instead](#). The Sub Window function enables a still picture by live picture mode. After assigning the Sub Window function to a function key the first key press will result in a picture by picture display of your active input. Once sub window mode is active you can press down on the H POS rotary knob to freeze the image on the right while the image on the left will continue to show your live source. Once frozen you can also switch to any other input provided that the resolution of that input is the same as the frozen source. To exit sub window simply press the assigned function key again.

Pixel Mapping

The Pixel Mapping function toggles between various available pixel mapping options. Options vary depending on the incoming source, but may include the following:

1:1 Pixel Mapping: 1 pixel of incoming source is displayed as 1 pixel on-screen. If the incoming source resolution is less than the total pixel count of the monitor your source will not fill the screen. This is often referred to as a postage stamp representation of the source. If the incoming source resolution is greater than the total pixel count of the monitor then only a portion of the incoming source will be shown on-screen, but the pixel position function (controlled by the H POS rotary knob) may be used to view different sections of the 1:1 pixel representation. The monitor's tally light will flash to remind you that you are in 1:1 pixel mapping mode if any portion of the image is not shown on screen when in 1:1. This pixel mapping mode can be combined with the SD Aspect Function (Anamorphic toggle) to activate a PAL SD FHA viewing mode on the monitor. Once pixel mapping is active pressing down on the H POS knob will move the source to a different on-screen position when pressed. Please note that if the incoming source is the same resolution as the panel the image will not move. On all native 1920x1080 or 1920x1200 resolution monitors this mode will allow you to view any portion of an incoming 2K source in an unscaled 1:1 on-screen representation.

2:1 Pixel Mapping (SD sources only): Every individual pixel of the incoming source is represented by four pixels onscreen. This scaling algorithm is simple and allows for a largely artifact free double size version of the 1:1 Pixel Mapping Mode for SD sources. While 2:1 scaling will still not fill the entire screen on a 1920x1080 resolution monitor, it does use a majority of the vertical screen height and provides an excellent quality large scale representation of the SD source.

Full Screen Mapping: The full screen mode will scale the incoming source to fill as much of the screen as possible while preserving the incoming source's native aspect ratio. If the incoming source and panel share the same resolution then there will be no difference between 1:1 pixel mapping and full screen pixel mapping. Please note that the Overscan function will be represented differently based on the pixel mapping selection that you select.

Pixel Position

This feature is a part of the Pixel Mapping function and provides a toggle for positioning a 1:1 Pixel to Pixel mapped representation of an incoming source on different areas of the screen. Once pixel mapping is active the H POS knob will move the source to a different on-screen position when pressed. Please note that if the incoming source is the same resolution as the panel the image will not move. The pixel position feature does not work unless the 1:1 Pixel to Pixel mapping mode function is turned On. On all native 1920x1080 or 1920x1200 resolution monitors this mode will allow you to view any portion of an incoming 2K source in an unscaled 1:1 on-screen representation.

H/V Delay Mode

This mode activates the Horizontal and Vertical Delay function to highlight the horizontal and vertical blanking portions of the incoming signal. This can be used in conjunction with the Video Data feature for specific analysis of Horizontal and Vertical Blanking data.

SD Aspect Ratio

Toggles between 4:3 and Anamorphic display of Standard Definition source. This function should be set to match the SD source being viewed. The default setting is 4:3. If used in conjunction with 1:1 pixel mapping this function can also activate a PAL SD FHA viewing mode.

Full Screen

This function simply stretches any incoming source to fill the entire screen. Unlike the Zoom feature this full screen stretch does not preserve aspect ratio, but it does keep all of the active video signal present. Though the full screen mode has many potential uses it was designed primarily for use with rasterizers that generate a 16:10 or 16:9 aspect 1024x768 output. Enabling Full Screen mode allows the monitor to stretch the image as intended by the rasterizer.

Pixel Zoom

The Pixel Zoom function will generate a positionable and resizable 16:9 rectangle on screen. The rectangle may be moved left or right using the H POS rotary knob and up or down using the V POS rotary knob. The Ref POS rotary knob may be used to change the size of the onscreen rectangle. Using these three rotary knobs you can select any area on screen and then press down on the F Stop rotary knob to zoom to the selected area. This pixel zoom feature is designed to work with any HD signal formats. A flashing tally light will be activated on your monitor whenever you are in a zoomed mode as a reminder/warning that the entire incoming signal is not being shown on the monitor. To exit the zoomed mode simply press down on the F Stop rotary knob once more. To exit the Pixel Zoom feature entirely simply press the function button assigned to this feature once more. The Pixel Zoom function allows for an essentially artifact free, high quality zoom on any portion of an HD signal.

LUM Coloring

This function generates an artificial luminance map of the incoming source that can be particularly useful in identifying overexposed areas in any given shot. An onscreen scale helps indicate what artificial color corresponds to what luminance level. The scale will follow the selected Waveform Scale set in the Scopes & VU Meters Profile 1: you can choose from IRE, Digital Levels, or Voltage. In its default configuration the LUM Coloring feature will highlight all levels above 100IRE as white and all levels below 0 IRE as black. In default mode levels between 0 and 100 IRE will be color coded. However, you can change the range of these color coded regions to any preferred setting by using the monitor's rotary knobs. The H POS rotary knob will adjust the lower limit of the lower color coded region. The V POS rotary knob will adjust the upper limit of the lower color coded region. The Ref POS rotary knob will adjust the lower limit of the upper color coded region. The F Stop Rotary knob will adjust the upper limit of the upper color coded region. These color coded ranges are retained in memory so you can exit and reenter LUM Coloring Mode without having to reset your desired threshold levels.



LUM Coloring with Custom Range



LUM Coloring with All Legal Levels Shown in Greyscale
Underexposed Areas in Blue
Overexposed Areas in Red

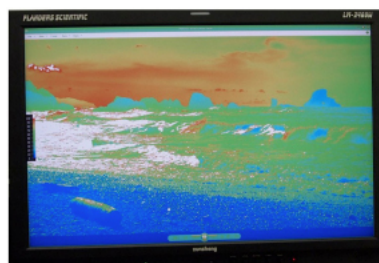

LUM Coloring in Default Mode
Overexposed Areas in White
Underexposed Areas in Black

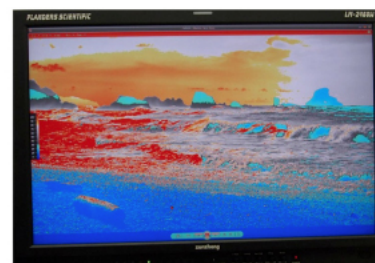

LUM Coloring with Custom Range

3D Disparity

This feature only works when SDI 1 and SDI 2 are the same frame rate / resolution and are genlocked. When active a disparity view will be shown on screen highlighting the difference between SDI 1 and SDI 2.

Measurement (10bit & 8bit)

This function allows you to get precise real time YRGB measurements of any point or area within your incoming signal. With the Measurement function on you can use the H POS and V POS rotary knobs to position your crosshair over the point within your source that you would like to measure. To reset the vertical or horizontal position of your crosshair back to center simply press down on the corresponding rotary knob. You may also use the Ref POS rotary knob to select the size of the sampling area for the measurement data (from a single pixel to a much larger area where the values will be an average of all pixels within your defined sample area). As you move the crosshair your Measurement data will update in real time. The Measurement function is available in a 10 bit mode or 8 bit mode and will provide you with the following data in real time:

- Line and Sample (Identifies position of your crosshair)
- Y (Luminance as an absolute value between 0-255 for 8 bit and 0-1023 for 10 bit)
- Y% (Luminance level expressed as percentage)
- R% (Red level expressed as percentage)
- G% (Green level expressed as percentage)
- B% (Blue level expressed as percentage)
- R (Red level as an absolute value between 0-255 for 8 bit and 0-1023 for 10 bit)
- G (Green level as an absolute value between 0-255 for 8 bit and 0-1023 for 10 bit)
- B (Blue level as an absolute value between 0-255 for 8 bit and 0-1023 for 10 bit)

You can also press the Ref POS rotary knob to set a reference position onscreen. Once your reference position is set it will be indicated on screen by a separate crosshair and you will be able to move the active crosshair to obtain a real time readout of your current and reference positions as well as a separate readout of the precise difference between current and reference locations. Please note that your reference position is both a spatial and temporal reference meaning that the values indicated on screen for the reference are for that point on screen at the moment you set the reference.

Pressing the F Stop rotary knob button allows you to set your current crosshair position as an F-Stop reference and view differences between this current position and your reference position as an F-Stop value. The F-Stop reference feature is independent of the Ref POS feature. The F-Stop reference value will always be based on the levels of your current active crosshair position at the precise moment when the F-Stop knob is pressed.

The crosshair color will follow the color selected for markers from the Marker Menu. To change the color of the Measurement function's crosshair change the Marker color.

Measure	Line	Sample	Y1024	R1024	G1024	B1024	Y%	R%	G%	B%	F/stop
Current	293	944	249	246	251	217	21.1	20.8	21.3	17.5	-0.0
Ref_Pos	316	994	240	240	241	219	20.1	20.1	20.2	17.7	-0.1
Diff	-24	-51	9	6	10	-2	1.0	0.7	1.1	-0.2	0.1

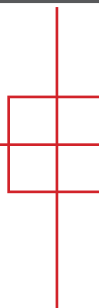

Video Data

The Video Data function is a sophisticated signal data analyzer providing realtime decimal or hexadecimal readout of video data at the pixel level. Data is represented in a 18 x 10 pixel grid where each pixel's corresponding color is used as the background color for that position within the grid. A small green rectangle on screen shows what area of the image is currently being analyzed. The grid position as well as the data readout can be manipulated with the rotary knobs as outlined below:

- H POS rotary knob moves the selected analysis point horizontally on screen. Pressing down on this knob returns you to the horizontal center of the screen.
- V POS rotary knob moves the selected analysis point vertically on screen. Pressing down on this knob returns you to the vertical center of the screen.
- Pressing down on the REF POS rotary knob toggles you between YCbCr and RGB data readouts.
- Turning the REF POS rotary knob toggles between decimal and hexadecimal data readouts.
- Turn the F STOP rotary knob to toggle between 8 bit and 10 bit data readouts.
- Pressing down on the F STOP rotary knob will cause the green position rectangle to flash white on screen to make it easier to locate.

	1075	1076	1077	1078	1079	1080	1081	1082	1083	1084	1085	1086	1087	1088	1089	1090	1091	1092
464	336	336	336	340	340	344	340	348	372	428	484	505	552	568	616	643	660	652
	475	475	479	479	483	483	490	490	501	501	513	513	525	525	535	535	543	543
	581	581	577	577	573	573	574	574	570	570	553	553	536	536	526	526	521	521
465	335	336	336	336	343	344	340	348	373	427	464	484	509	564	620	652	667	652
	471	471	475	475	479	479	486	486	497	497	509	509	524	524	537	537	542	542
	581	581	577	577	576	576	576	576	570	570	553	553	536	536	526	526	521	521
466	336	336	336	336	344	344	340	348	372	428	448	477	524	568	620	652	668	652
	468	468	471	471	475	475	485	485	495	495	509	509	524	524	537	537	542	542
	581	581	580	580	577	577	576	576	570	570	553	553	536	536	526	526	521	521
467	332	336	336	336	343	344	340	348	372	427	436	473	540	576	620	652	664	653
	464	464	467	467	471	471	478	478	492	492	508	508	524	524	537	537	544	544
	581	581	580	580	577	577	576	576	570	570	553	553	537	537	526	526	521	521
468	332	336	336	337	340	345	337	347	368	416	444	489	544	584	628	656	663	652
	464	464	467	467	471	471	478	478	492	492	508	508	524	524	538	538	543	543
	581	581	580	580	577	577	576	576	570	570	553	553	536	536	525	525	521	521
469	333	336	336	336	340	345	331	348	364	404	456	504	544	592	636	655	663	653
	464	464	468	468	471	471	478	478	492	492	508	508	524	524	537	537	543	543
	581	581	580	580	577	577	575	575	570	570	553	553	536	536	525	525	521	521
470	333	336	336	336	339	340	344	360	376	417	464	520	560	604	648	656	666	652
	468	468	471	471	475	475	482	482	493	493	511	511	525	525	537	537	543	543
	581	581	577	577	576	576	573	573	569	569	552	552	536	536	526	526	521	521
471	332	336	336	335	341	340	356	372	389	428	473	540	580	619	659	656	652	652
	469	469	471	471	475	475	482	482	496	496	512	512	525	525	535	535	539	539
	577	577	575	575	573	573	572	572	566	566	552	552	536	536	527	527	521	521
472	332	336	336	340	340	351	368	384	412	448	495	556	596	628	652	652	652	655
	471	471	475	475	477	477	485	485	500	500	513	513	527	527	535	535	539	539
	577	577	576	576	573	573	570	570	562	562	548	548	535	535	528	528	522	522
473	336	340	340	340	353	367	380	397	425	472	524	572	616	640	648	648	652	656
	471	471	475	475	482	482	493	493	505	505	515	515	528	528	535	535	539	539
	577	577	576	576	573	573	569	569	562	562	548	548	536	536	529	529	522	522

Video Data [YCbCr] [10BIT] [Decimal] [Line: 471] [Sample:1077]

The Video Data function can also be used in conjunction with the H/V Delay function. When you enable H/V Delay with Video Data active you will see a Full Raster position indication appear at the bottom of the Video Data window. This provides your cursor position in the order Line then Sample relative to the full raster instead of just the active picture data. This can be useful for finding and analyzing specific Horizontal and Vertical blanking data. If analyzing an interlaced source putting the monitor in Noise Reduction processing mode will make the data easier to read.

[Full Raster: 21 x 13]

CIE Measurement

This function allows you to get precise real time chromaticity measurements of any point or area within your incoming signal as well as a real time plot of the measured position on a CIE color space diagram. With the CIE Measurement function on you can use the H POS and V POS rotary knobs to position your crosshair over the point within your source that you would like to measure. To reset the vertical or horizontal position of your crosshair back to center simply press down on the corresponding rotary knob. You may also use the Ref POS rotary knob to select the size of the sampling area for the measurement data (from a single pixel to a much larger area where the values will be an average of all pixels within your defined sample area). As you move the crosshair your Measurement data and plot will update in real time. The CIE Measurement function will provide you with the following data in real time:

- Line and Sample (Identifies position of your crosshair)
- R' (Red signal level percentage normalized to 10 bit data range)
- G' (Green signal level percentage normalized to 10 bit data range)
- B' (Blue signal level percentage normalized to 10 bit data range)
- Y% (Luminance level as percentage)
- x (CIE 1931 x chromaticity coordinate)
- y (CIE 1931 y chromaticity coordinate)
- u' (CIE 1976 u' chromaticity coordinate)
- v' (CIE 1976 v' chromaticity coordinate)
- dE2000 (difference between current & reference expressed as dE2000 value)

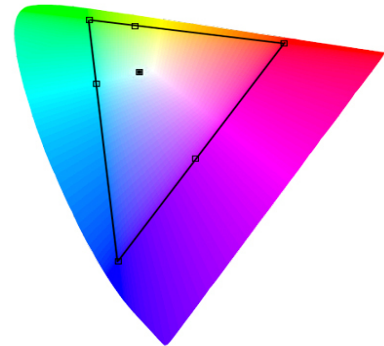

You can press the Ref POS rotary knob to define a reference position on screen. Once your reference position is set it will be indicated on screen by a separate crosshair and you will be able to move the active crosshair to obtain a real time readout of your current and reference positions as well as a separate readout of the precise difference between current and reference locations. Please note that your reference position is both a spatial and temporal reference meaning that the values indicated on screen for the reference are for that point on screen at the moment you set the reference.

Pressing the F Stop rotary knob button allows you to toggle the CIE color space diagram between CIE 1931 and CIE 1976 views. Your chromaticity plots are calculated using signal input data relative to your active Color Space selection on the Color Management menu. Since your reference color gamut for chromaticity calculation follows this selection it allows you to have Rec709, DCIP3, EBU, or SMPTE C as your reference color gamut. Please note that if you have the Color Space selection set to Wide Gamut or a custom USER position the reference gamut used for the CIE Measurement feature will default to Rec709.

The crosshair color will follow the color selected for markers from the Marker Menu. To change the color of the CIE Measurement function's crosshair change the Marker color.

CIE	Line	Sample	R'	G'	B'	Y%	x	y	u'	v'	dE2000
Current	542	960	971	0	1	18.93	0.6400	0.3300	0.4507	0.5229	
Ref_Pos	541	961	1023	1023	1023	100	0.3127	0.3290	0.1978	0.4683	
Diff	1	-1	-52	-1023	-1022	-81.7	0.3273	0.0010	0.2529	0.0546	47.678



CIE Scope

This function maps out full frame signal data on a CIE diagram. Signal levels are mapped out relative to your active color space selection on the Color Management menu. Your active color space selection is represented by a black triangle on the CIE diagram.

If you have one of the custom User Color Space selections active then this reference gamut will default to Rec709. In addition to the primary color gamut indication (black triangle) you can press down on the V POS rotary knob to generate a secondary color gamut overlay as a grey triangle. This secondary color gamut overlay is purely for comparative reference and does not influence how signal levels are mapped relative to the primary color gamut selection.

The CIE diagram may be toggled between CIE 1931 and CIE 1976 views by pressing down on the H POS rotary knob.

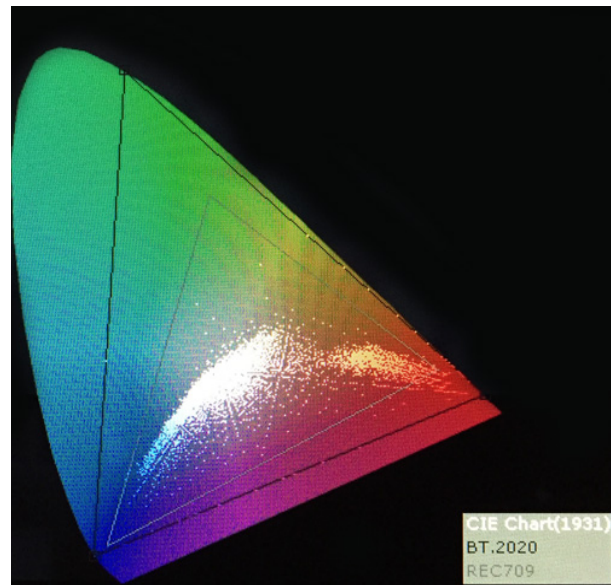

This is a very processor power intensive feature and video quality, specifically video sharpness, will be degraded while active. For this reason we suggest using the CIE Scope feature as needed for specific color gamut analysis, but we do not recommend leaving the feature enabled at all times.

4K Display

This feature is specifically for monitoring Dual 3Gbps SDI (6G total bandwidth) 4K signals. In addition to this feature you may also monitor a quarter resolution sampled image by sending one link of a Two Sample Interleave (2SI) Quad SDI signal.

Blue/Red/Green Only

This function activates the monitor's Blue Only, Red Only, and Green Only modes. The respective channels can be shown as just that color (Red, Green, Blue) or as monochrome.

Still Frame

This function allows you to freeze a video source at anytime. To unfreeze simply press the function key assigned to Still Frame a second time.

Variable Wipe

When monitoring a Level B 3Gbps SDI signal comprised of two multiplexed 1.5Gbps HD-SDI signals the monitor will allow you to view these signals in a vertical or horizontal split screen mode. By activating the Level B Variable Split function while in split screen mode the positioning of the split can be adjusted using the H POS rotary knob. To quickly reset the split screen positioning to the default center position simply press down on the H POS rotary knob while the Variable Wipe function is active. Once your desired split screen wipe position is set you can turn the Variable Wipe function off to remove the guide line between the two signals. This feature can also be used with the Horizontal and Vertical Split PAP modes using two distinct signals fed to SDI 1 and SDI 2 on the monitor.

CX Scale

This scaling mode was designed specifically to allow the scaled down and top centered 'gate check' output from Codex™ ARRIRAW Recorders to be scaled full screen. Once assigned to a function key you can quickly enter or exit this custom scaling mode with a single button press. Please note that some functions, such as markers, will not work while this mode is active. However, other useful functions such as Waveform and Vector Scope will continue to operate normally.

Max Sharpness

In addition to the Sharpness Level Setting found on the Video Menu there is an assignable function called Max Sharpness that will allow you to use a function button to toggle in/out of maximum sharpness mode quickly.

Focus Assist

The focus assist feature is comprised of two main parts: a numerical focus meter and a graphical focus highlight. The numerical focus meter is shown on screen as your current focus value over your reference focus value (i.e. 560/300). When the focus assist feature is activated the rotary knob labeled Ref POS allows you to adjust the reference focus value. The reference focus value represents the in-focus threshold for the focus highlight portion of the focus assist feature. Adjusting the focus reference value higher means that the threshold at which the focus highlight begins to trace in-focus items with a red boundary will be higher. In other words a greater degree of focus will need to be achieved before the focus highlight feature is visible on screen as a red trace around in-focus objects.

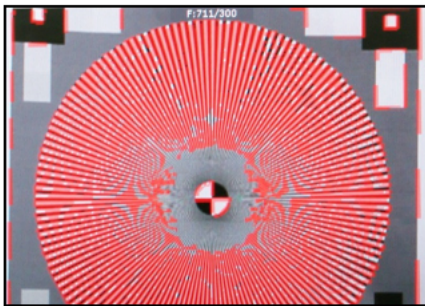

In Focus Shot with Default Focus Reference Value

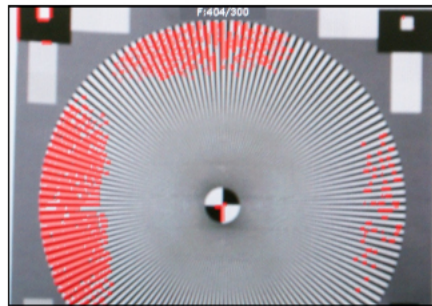

Less Focused Shot with Default Focus Reference Value

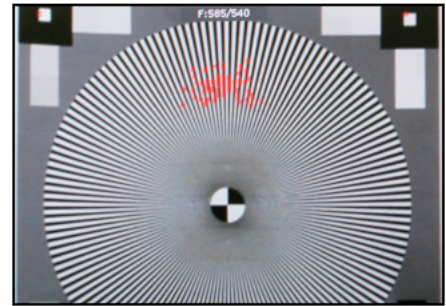

Example of Shot with Focus Reference Value Turned Up

C-Log, S-Log, S-Log2, S-Log 3 and BMD-Log Modes (Also selectable via Video Menu)

These modes allow for easier on-set monitoring of uncorrected C-Log, S-Log, S-Log2, S-Log3, or BMD Cinema Camera Film Mode Output by roughly normalizing the footage. For all Log modes there is both a Standard and Full selection. The Standard selection is suitable for most applications, but does clip highlights to allow for a brighter overall image. The Full mode is best used for scenes with extremely wide latitude or scenes that are just very bright overall. Full mode preserves the entire native latitude of the signal (nothing is clipped), but this can result in a rather dark image in many applications. We provide both for this reason and you can quickly toggle between them as needed for different applications by assigning these modes to function keys. These modes should only be used to offer on set viewers a rough normalization of the footage to give them an idea of what the content might look like as a starting point in post production. In other words, it provides you with a helpful tool to show on set viewers something that does not look 'flat'. These modes are not a replacement for full 3D LUT transforms and not a substitution for proper color correction in post production applications. For more advanced Log mode normalization use a custom 3D DIT LUT.

On-Screen Tally

When activated this function will generate an onscreen box that mirrors the status of the physical tally on the monitor's bezel. This can be particularly useful in applications where the physical tally may be obscured.

Zoom

This function zooms in on the incoming source until the entire screen is filled. This is strictly a zooming function and does not alter the native aspect ratio of the source to fill the screen. When viewing a 4:3 source in Zoom mode on a 16:9 display the aspect ratio of the visible video will remain 4:3 though the entire 16:9 screen will be filled. Essentially the Zoom mode results in viewing a 16:9 section of the 4:3 source and is most useful when viewing a letterboxed SD source on a widescreen display so that the letterboxing is not shown and only the video within the letterboxing is present.

DSLR Zoom

This function is designed to be used with many popular DSLR cameras that have preview/record monitoring output in 1080 & 480 resolutions. When DSLR Zoom is active the 16:9 area that will be recorded is scaled to fill the screen. On DSLR cameras that switch from 1080 to 480 while recording the DSLR Zoom can be left on and the same correct aspect zoom will be maintained regardless of whether the DSLR is in preview or recording mode. While DSLR Zoom is active the markers may also be turned on and will be correct relative to the 16:9 video that will be captured to the camera's memory card. Please note it may be necessary to toggle the viewing mode preference (Info button on many DSLRs) to fill the screen correctly.

DSLR Zoom (continued)

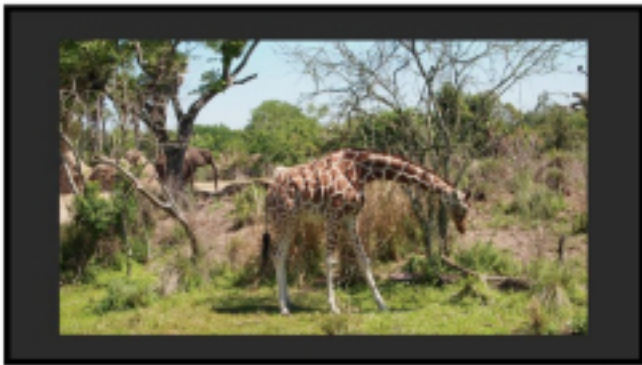

DSLR in 1080i Preview with DSLR Zoom feature Off

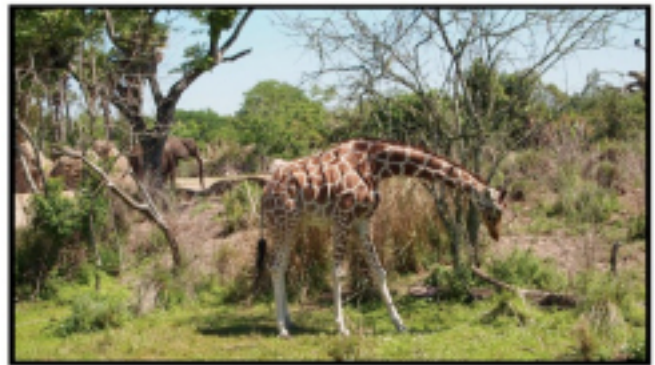

DSLR in 1080i Preview with DSLR Zoom Feature On

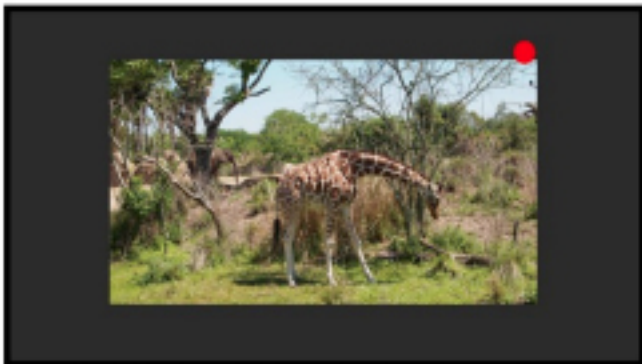

DSLR in 480p Record Mode with DSLR Zoom feature off

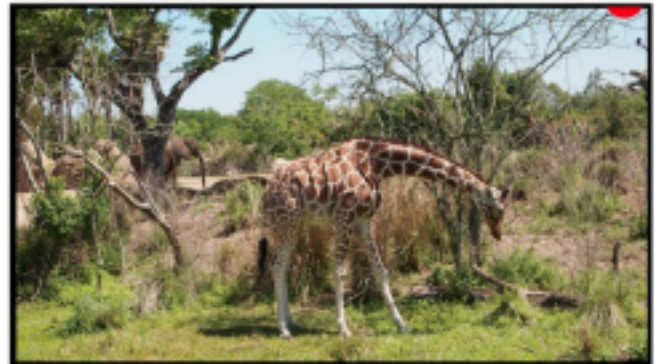

DSLR in 480p Record Mode with DSLR Zoom feature On

Safety Broadcast

Safety Broadcast is a special monitoring mode designed for Control Room and QC station environments. With Safety Broadcast mode activated you can have simultaneous display of two audio level meters, Enhanced Source ID display (large overlay, remotely or manually set), Enhanced Alarm Window Display (large window, red background), and enhanced timecode display (large timecode overlay window).

Please note that as with the standard Alarm Monitoring feature the monitor may respond slowly to user toggles/inputs if a constant alarm condition is occurring. Toggles for UMD Display, Color, and Position are found in the Alarm Menu. Vertical or Horizontal Safety Broadcast Audio Meter selection is also found in the Alarm Menu.



AFD (Active Format Description)

Activating this function will enable an Active Format Description reader on the monitor that will provide both a text readout of AFD data and display corresponding markers onscreen indicating the portions of the image described by the AFD code. If no AFD data is present while this feature is active the monitor will show AFD: NONE in its AFD readout window.

AFD: 0x0d
code frame 16:9
active image 4:3
image position horizontal center
with alternative 14:9 center

Anamorphic Desqueeze

This feature gives you the ability to desqueeze HD signals coming from cameras utilizing anamorphic lenses that may not have a built in desqueeze feature of their own. This can be particularly useful in applications outside of post production, especially onset monitoring, where de-squeezing such signals in real-time may otherwise not be possible. The desqueeze modes available are 1.3, 1.3mag, 2.0, and 2.0mag. This feature is in addition to, and not a substitute for, the SD Aspect Ratio function. To use this feature set Anamorphic Desqueeze to a function button, which will allow you to toggle the desqueeze on and off. To set the desqueeze ratio/magnification go to the Video Menu and select your desired Anamorphic Desqueeze mode.

Anamorphic Desqueeze Modes



1.3x Anamorphic Original



1.3x Anamorphic Desqueeze



2.0x Anamorphic Original



2.0x Anamorphic Desqueeze



2.0x Anamorphic Original



2.0x mag Anamorphic Desqueeze

Rec. Status Tally

This function is designed for use with cameras that output Start/Stop Record flags in the ancillary data of their serial digital output. To activate this function set Rec. Status Tally to a function button and press that function button once. While active the monitor's red tally light will turn on when the Start Record SDI flag is detected and will turn the red tally light off when the Stop Record SDI flag is detected.

PAP - Live Side by Side and Picture In Picture Viewing

On BM and CM series monitors (excluding CM-170W) corresponding controls can be found in the Video Menu to change your PAP Secondary Input and PAP Mode, allowing you to select Picture In Picture, Picture And Picture (Side-By-Side Monitoring), Picture On Picture, Vertical Split Screen, or Horizontal Split Screen. You can use the Variable Wipe function in conjunction with the Vertical and Horizontal Split modes to set a custom split position other than the default of center screen.

As of firmware version 1.1.03-2144 you can page through the different PAP viewing modes using the up and down arrow keys while the function is active.

Dual Link

CM & BM series units equipped with FSI's second generation Color Fidelity Engine (CFE2) can support Dual Link SDI (2 x 1.5Gpbs SDI) in addition to single link 3Gbps SDI for advanced signal format support. 3Gbps SDI is the preferred connectivity method if available, but if single link 3Gbps SDI output from your source is not available you can use the Dual Link function to activate Dual Link SDI support. To activate this capability first select SDI 1 as your input. Then set Dual Link to a function button. Then press that designated function button to turn on Dual Link mode. Once active you may need to set your SDI format manually if no payload ID is present in the signal. To do this go to the SDI format section of the Video Menu and select the appropriate format.

DIT LUT

Use to activate DIT (Look) LUTs stored to the monitor. Scroll between LUT positions using the monitor's up and down keys. See Appendix A for details on saving DIT (Look) LUTs to the monitor.

Main Menu	Scopes & Audio Meters	
Function	Scopes & Audio Meters	Profile 1
Scopes & Audio Meters	Window 1	Luminance
Video	Window 2	Vector
Audio	Waveform Position	Bottom Right
Marker	Scopes Stack	Horizontal
Alarm	Waveform Scale	IRE Level
OSD	Audio Display Mode	Pairs
GPI	Alignment Level	-18 dBFS
Color Management	Permitted Max Level	-9 dBFS
System	Audio Display Channels	1-16
System Status	Ballistics	True Peak
Support	Peak Hold Time	2

NOTE: The Scope & Audio Meters Menu only sets your Waveform, Vector, & Audio Level Meter display preferences. To toggle the onscreen display of your configured Scopes & VU Meters profiles assign the Scopes & VU Meters profiles to specific keys. See the Function Menu section of this manual for more details.

Scopes & Audio Meters Profile 1, 2, 3

The Scopes & Audio Meters menu allows you to setup three Scopes & Audio Meters Profiles, each capable of storing all of the configurable settings found on the Scopes & Audio Meters Menu. To configure a Profile simply select the Profile number, 1 through 3, from the top of the Scopes & Audio Meters menu page. Once you have selected the desired profile number any settings you change will become associated with that profile number. Changing from one profile to another from the Scopes and Audio Meters menu will automatically recall your last settings for that profile. Once you have configured your Scopes & Audio Meters profiles you can assign a specific function key to a particular profile, which allows you to instantly switch between different types of Scope and/or Audio Meters modes without having to go back into the onscreen menu.

Window 1 & Window 2

Two scope windows can be displayed simultaneously so you can view any two of the following modes at the same time: Luminance (Standard Waveform), Vector Scope, Hue Vector*, RGB Parade, GBR Parade, RGB Overlay, YCbCr, YCbCr Overlay, Column (YRGB Peak), Histogram, Color Histogram, RGB Histogram, Audio Loudness, Audio Phase, and Vertical Audio Level Meter. Please note that displaying two Scope Windows at the same time will cause the Scopes to update more slowly than displaying just one Scope Window. To display just one scope Window select OFF in the secondary window selection. An additional audio level meter mode called horizontal audio level meter is also selectable. This mode displays meters horizontally across the top of the screen, but cannot be used in conjunction with any other Scope modes. **Waveform Intensity and Gain can be adjusted by turning the H POS and V POS rotary knobs. Default Scope Intensity as of firmware version 9.42 is 75% of the maximum level. Hue Vector Intensity, Gain, Reference Vector Angle, and Percentage of Reference Vector can be adjusted with the H POS, V POS, Ref POS, and F Stop rotary knobs. Audio Loudness metering can be paused and reset using the H POS rotary knob.**

**Hue Vectors graticule designed by Alexis Van Hurkman and used under Creative Commons License..*

Waveform Position

Use the Waveform Position toggle to select in what area of the screen you would like your Scopes to be displayed.

Scopes Stack

Use this option to select whether the Scope Windows are stacked vertically or positioned horizontally next to each other when utilizing two Scope Windows.

Waveform Scale

This option allows you to choose what type of scale is used on the Waveform Monitor. You may select from V Level (for a voltage based scale), IRE Level (for an IRE based scale 0-100), or Digital Level (for a 8 bit digital level based scaled, 0-255).

Main Menu	Scopes & VU Meters	
Function	Scopes & VU Meters	Profile 1
Scopes & Audio Meters	Window 1	Luminance
Video	Window 2	Vector
Audio	Waveform Position	Bottom Right
Marker	Scopes Stack	Horizontal
Alarm	Waveform Scale	IRE Level
OSD	Audio Display Mode	Pairs
GPI	Alignment Level	-18 dBFS
Color Management	Permitted Max Level	-9 dBFS
System	Audio Display Channels	1-16
System Status	Ballistics	True Peak
Support	Peak Hold Time	2

NOTE: The Scope & VU Meters Menu only sets your Waveform, Vector, & Audio Level Meter display preferences. To toggle the onscreen display of your configured Scopes & VU Meters profiles assign the Scopes & VU Meters profiles to specific keys. See the Function Menu section of this manual for more details.

Audio Display Mode

This option can be set to either Groups or Pairs. When organized in pairs the odd channels will be displayed on the left side of the screen and even channels of the right side of the screen. When organized in groups the channels will be arranged with all channels of an Audio Group displayed on the same side of the screen together.

Alignment Level

Allows audio level meter alignment level to be set to -12dBFS, -14dBFS, -16dBFS, -18dBFS or -20dBFS, -22dBFS.

Permitted Max Level

Allows you to specify the Max Audio Level for your onscreen Audio Level Meters: Select from: -10 dBFS, -9 dBFS, -8 dBFS, -7 dBFS, -6dBFS, -5dBFS.

Audio Display Channels

Allows you to select the Audio Level Meters Channels that will be shown on the Vertical or Horizontal Audio Level Meters. Select from Channels 1-2, 1-8, 9-16, or 1-16.

Ballistics

This allows you to select the type of Audio Level Meters to display. You can select from PPM Type I, PPM Type II, or True Peak.

Peak Hold Time

Allows you to specify the number of seconds that a peak audio level will be held (shown) by the Audio Level Meters.

Luminance

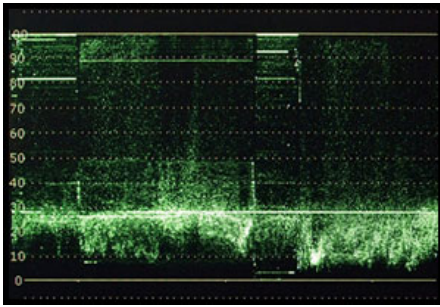

Vector Scope

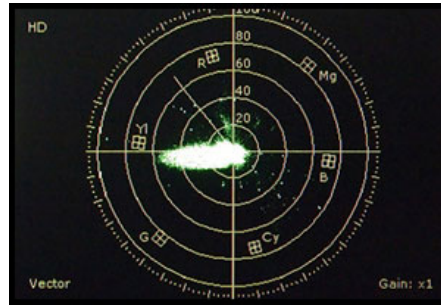

Hue Vector

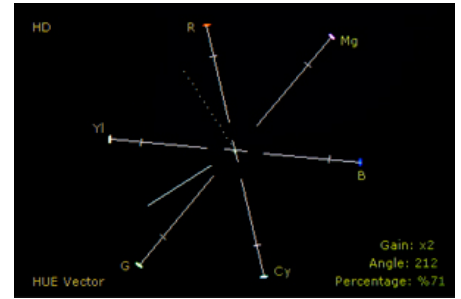

RGB & GBR Parade

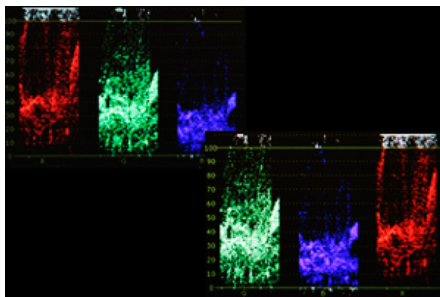

Color Histogram

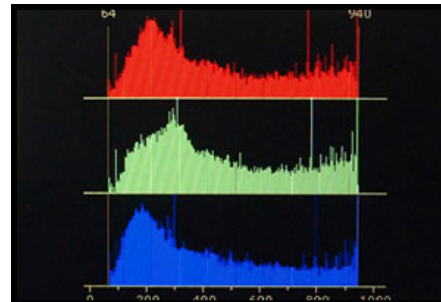

YCbCr

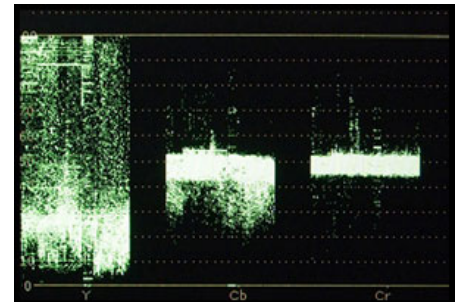

RGB Histogram

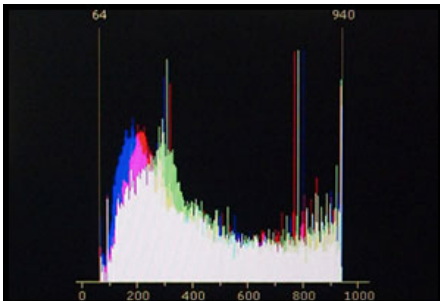

Column (YRGB Peak)

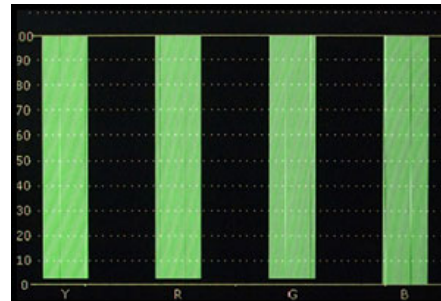

Histogram

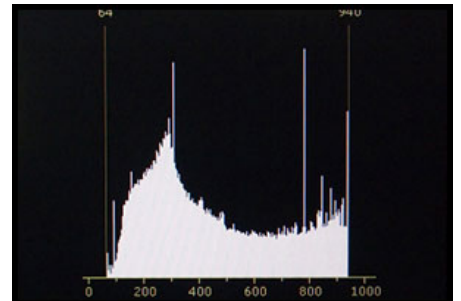

YCbCr Overlay

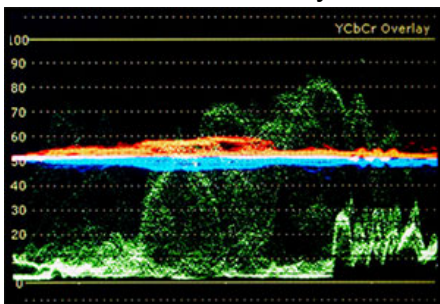

RGB Overlay

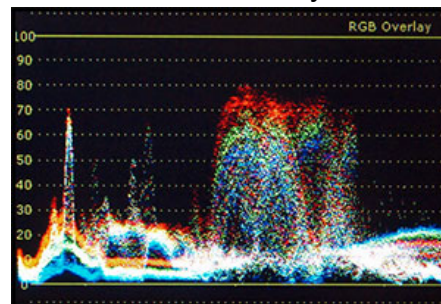

Audio Phase Meter

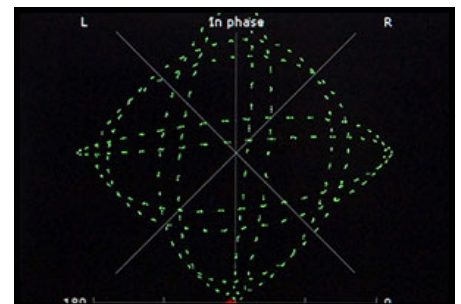

Audio Level Meters

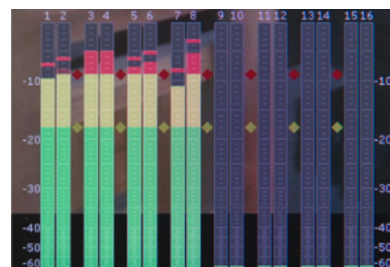

Audio Loudness

Ch	10s(LKFS)	Avg(LKFS)	10s(LKFS)	Avg(LKFS)
01	-7.92	-7.92	-6.33	-6.33
02	-11.45	-11.45		
03	-10.20	-10.20		
04	-11.43	-11.43	-7.76	-7.76
05	-14.09	-14.09		
06	-13.84	-13.84	-10.95	-10.95
07	-10.20	-10.20	-7.76	-7.76
08	-11.42	-11.42		
09	-91.01	-91.01		
10	-91.01	-91.01		
11	-91.01	-91.01		
12	-91.01	-91.01		
13	-91.01	-91.01		
14	-91.01	-91.01		
15	-91.01	-91.01		
16	-91.01	-91.01		

Main Menu	Video	
Function	SDI Format	Auto
Scopes & Audio Meters	3G Level B	Stream 1
Video	DVI Select	DVI-D
Audio	DVI Pixel Format	Full RGB
Marker	CVBS Setup	7.5 IRE
Alarm	Component Input	Component
OSD	Component Pixel Format	YPbPr
GPI	Component Setup	YPbPr SMPTE/N10
Color Management	PAP Mode	PAP
System	PAP Input	SDI 2
System Status	Checkerboard Size	2 Pixels
Support	SD Enhancement	Off
	Anamorphic Desqueeze	2.0x
	Signal Mode	Auto
	Processing	Normal Mode
	Show psF as	Interlaced
	Sharpness Level	0
	Flicker Free Mode	Off
	Part Display	Off

Menus longer than the Main Menu including Video, Color Management, and the System menu will not fully display. These menus will scroll.

Use the Up and Down keys to scroll up and down a menu.

SDI Format

FSI Monitors are capable of detecting the payload ID contained in an SDI signal. However, some sources or upstream equipment may not generate or pass payload ID. For sources lacking proper Payload ID you may override the SDI Format auto detect function and manually select the appropriate format. It may be necessary to force the monitor to re-sync to a signal when changing formats at the source even when set to Auto. You can force the monitor to re-sync by either reselecting Auto from the SDI Format menu, selecting the appropriate format manually from the SDI Format Menu, or simply toggling to another input and back to the input in use. Please note that on monitors with a selectable color space option that XYZ signals will be mapped to the color space selected on the Color Management menu.

3G Level B

When monitoring a 3Gbps SDI Level B signal (monitor must be equipped with 3Gbps SDI Inputs) comprised of two distinct 1.5Gbps HD-SDI signals that have been muxed together you can use this 3G Level B selection to select different monitoring options including: Stream 1, Stream 2, PAP, PIP, POP, Vertical Split, Horizontal Split, Overlay Mode. Please note that Level B 3Gbps SDI requires that both 1.5Gbps signals share the same frame rate and resolution and that Link A and Link B are genlocked. For signals using SMPTE 425M-B image format mapping to transport SMPTE 372M formatted Dual Link information (4:4:4 YCbCr or RGB) the Overlay Mode should be used to view the combined LinkA and LinkB data as a single video signal.

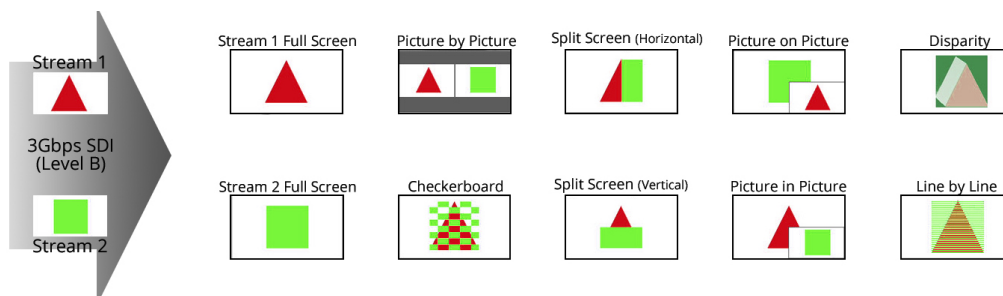

3G Level B 3D Monitoring Modes

FSI's passive 3D technology 3D monitors, such as the CM500TD and CM420TD, are equipped with a circular polarizing filter that allows signals that have been interleaved before reaching the monitor to be viewed in 3D by simply viewing the content through passive polarized 3D glasses. However, in addition to viewing interleaved sources FSI's 3D monitors can also accept two full resolution sources that have been multiplexed over 3Gbps SDI and interleave them for 3D viewing. If you have such a 3G Level B signal comprised of full resolution left and right eye channels you can select Line by Line from the 3G Level B Menu selection, which will instruct the monitor to interleave the sources and display them onscreen for 3D viewing through passive 3D glasses. In addition to this Line by Line mode all FSI monitors with 3Gbps SDI inputs will have the following diagnostic modes for monitoring 3D signals without glasses:

3D Checkerboard: Checkerboard display of both signals with alternating blocks shown from Link A and Link B of the multiplexed 3Gbps SDI signal. The checkerboard size is adjustable using the Checkerboard Size menu option.

3D Disparity: This shows an overlay of Link A and Link B with differences between the links highlighted.

Stream 1, Stream 2, PAP, Horizontal Split, and Vertical Split: As with all Level B 3Gbps SDI signals these 3G Level B viewing modes can be useful for analyzing and comparing Left and Right Eye streams.

**Helpful Tip: When viewing 3D signals on any passive 3D device try to sit as eye level to the center of the screen as possible. Viewing from the left or right of center should not prevent proper 3D viewing, but passive 3D technology has a very small vertical position window. If the monitor is viewed from too high or too low of a position the 3D image will not be seen properly.*

DVI Selection & DVI Pixel Format

BM & CM series monitors are equipped with a DVI-I Input, which supports both DVI Digital and DVI Analog sources. To select between DVI-D (Digital) and DVI-A (Analog) simply toggle this control accordingly. Use DVI Pixel Format to select between Full RGB (0-255), Limited RGB (16-235), or YCbCr modes.

CVBS Setup

Toggle between 0 or 7.5 IRE setup selection for Composite sources.

Component Input

Toggle between Component & Composite Video on units with shared analog inputs.

Component Pixel Format

Component Pixel Format toggles the analog Component video inputs between YPbPr or RGB mode.

Component Setup

Using the Component Setup feature allows you to specify what type of component signal you are sending to the monitor. Select from YPbPr SMPTE/N10, YPbPr Betacam, YPbPr MII.

PAP Input

Select the secondary input for use with the Picture and Picture function, the primary input is the actively selected input from the monitor's keypad.

PAP Mode

Select between Picture In Picture, Picture On Picture, and Picture And Picture for the PIP Function.

SD Enhancement

Applies maximum sharpening and video quality enhancement to SD video sources.

Anamorphic De-Squeeze

Toggles between 1.3, 1.3mag, 2.0, and 2.0mag HD Anamorphic Desqueeze ratios. This is used in conjunction with the Anamorphic Desqueeze function described in the Function Menu portion of this manual.

Signal Mode

Selecting 'Film' for this setting allows the monitor to compensate for material with 2:3 pulldown to provide a smoother image. Selecting 'TV' for this setting processes the incoming video signal with no 2:3 pulldown compensation. Selecting 'Auto' will automatically trigger 'Film' mode anytime 2:3 pulldown is detected.

Processing

The Processing setting has three options: Normal, Fast, & Noise Reduction. In Normal mode the monitor will display interlaced video as interlaced and have a very low latency processing delay. In Fast mode the video processing delay is further improved to provide the lowest possible processing latency, but ancillary functions and menu displays are updated more slowly. In Noise Reduction mode video processing delay is increased to allow for additional noise reduction processing and the monitor will deinterlace the signal and display it as progressive.

Show PsF as

Select between Interlaced or Progressive to instruct the monitor how to handle and show PsF content on screen. Set to interlaced for lowest possible processing delay. Set to Progressive to see on screen as Progressive as intended. Please note that some features, like Horizontal Audio Level Meters, are NOT compatible with 'Show PsF as' set to Progressive.

Sharpness Level

This function is a peaking level adjustment and produces an effect very similar to a physical aperture adjustment. By adjusting sharpness lower the image will look softer and by adjusting sharpness higher the image will look sharper. Please note that perceived sharpness may also be affected by video processing and pixel mapping settings.

Flicker Free Mode (Only applies to OLED units)

When turned ON this mode eliminates the low frame rate flicker typical of OLED monitors with ultrafast pixel response times. On is the default setting, we recommend keeping it activated.

Part Display

Toggles whether just the center part (On) or entire source (Off) is shown in Sub Window Mode.

Main Menu	Audio	
Function	SDI 1 Audio	Digital CH1&2
Scopes & Audio Meters	SDI 2 Audio	Digital CH1&2
Video	DVI-D Audio	Digital CH1&2
Audio	DVI-A Audio	Analog
Marker	Component Audio	Analog
Alarm	Composite Audio	Analog
OSD	Audio Sync	Signal Clock
GPI	Audio Lockout	Off
Color Management		
System		
System Status		
Support		

SDI 1 Audio

Select which audio source is active (audible) when SDI 1 is the selected video input. You may select any single channel or stereo pair of embedded audio (i.e. Digital Channel 1, 1&2, 3&4, etc.), Analog Audio (from minijack input), or No Sound. The active stereo pair selected here will be the stereo pair shown when the Audio Phase Meter is activated on the SDI 1 Input.

SDI 2 Audio

Select which audio source is active (audible) when SDI 2 is the selected video input. You may select any single channel or stereo pair of embedded audio (i.e. Digital Channel 1, 1&2, 3&4, etc.), Analog Audio (from minijack input), or No Sound. The active stereo pair selected here will be the stereo pair shown when the Audio Phase Meter is activated on the SDI 2 Input.

DVI-D Audio

Select between Analog Audio input (via minijack connector) or No Sound when DVI-Digital is the selected video input. On monitors shipped AFTER October 27th, 2014 you can also use the Channel 1 & 2 selection listed here for stereo HDMI audio support when using a HDMI or Display Port to DVI cable.

DVI-A Audio

Select between Analog Audio input (via minijack connector) or No Sound when DVI-Analog is the selected video input.

Component Audio

Select between Analog Audio input (via minijack connector) or No Sound when Component Video is the selected video input.

CVBS Audio

Select between Analog Audio input (via minijack connector) or No Sound when Composite Video is the selected video input.

Audio Sync

Choose between Signal Clock or Internal Clock for Audio Sync. Some embedded audio sources may have a poor quality signal clock that may lead to audio distortion. Switching to Internal Clock can help to eliminate or minimize such distortion.

Audio Lockout

When set to On, this feature will lock the Volume Knob, which retains the last used audio setting used. With Audio Lockout On, no adjustments to volume will be possible.

Main Menu	Marker	
Function	Marker Select	Profile 1
Scopes & Audio Meters	Graticules	Off
Video	Graticules Info	On
Audio	Area Marker	4:3
Marker	Safety Marker	90%
Alarm	Center Marker	On
OSD	Marker Color	Gray
GPI	Marker Background	Normal
Color Management	Safety In Area	On
System	Active Boundary	Off
System Status		
Support		

NOTE: The Marker Menu only sets your marker preferences. To toggle the onscreen display of your configured marker assign the Marker function to one of the function keys. See the Function Menu section of this manual for more details.

Marker Select

Toggles between three Marker Profiles. Each profile stores all marker preferences and can be recalled from the function menu by assigning a function button to a specific marker profile.

Graticules & Graticules Info

Toggles Custom Marker Feature On/Off. Use rotary knobs to adjust line positioning. Set Graticules Info to Off to clear line position and span size readouts.

Area Marker

Use the Area Marker function to select what type of marker is displayed when the marker function is active. The marker selections available from this option include most commonly used markers and more complex user designed custom markers. Area Markers and Safety Markers may be displayed simultaneously provided that the Marker Background function (described below) is set to Normal.

Safety Marker

Use the Safety Marker function to toggle the size, in percentage, of the safety marker displayed. This option can be used by itself or in conjunction with the Area Marker function provided that the Marker Background function (described below) is set to Normal. The Safety Marker may be displayed relative to the incoming source or relative to the Area Marker by toggling the Safety in Area option on or off from the Marker Menu.

Center Marker

Toggles whether the center marker (crosshair) is displayed when the marker is activated.

Marker Color

This setting allows you to select the color of the marker being used. This can be especially useful when one color dominates the screen and an easily visible high contrast marker is desired.

Marker Background

The Marker Background setting can be used to toggle how the area that lies outside of the Area Marker or Safety Marker boundaries is represented. You can select from Normal, Transparent, or Solid.

Safety in Area

Toggles whether Safety Marker is shown relative to incoming source or relative to the Area Marker (i.e. 4:3)

Active Boundary

When turned on, the Active Boundary marker will highlight the edges of any active video area not directly bordering the monitor's bezel. This is useful for detecting missing lines in the active video area.

Main Menu	Alarm
Function	Alarm Off
Scopes & Audio Meters	Visual Alarm Off
Video	Remote Alarm Monitoring Off
Audio	IRE Trigger Level 100 IRE
Marker	Audio Trigger Time 3s
Alarm	Audio Phase Indicator Off
OSD	UMD Display UMD
GPI	UMD Color White
Color Management	UMD Position Top
System	Audio Meter Vertical
System Status	Select Alarm Area
Support	

NOTE: Onscreen Alarms are processing power intensive. When active the monitor may respond more slowly to user input via buttons/remote control if a large number of successive alarm events are occurring. Switching to an unused input with no video will allow the monitor to respond quickly to user input should the operator simply want to turn Alarm monitoring off in scenarios where monitor menu response is slowed by such successive alarm events.

The monitor's built in Alarm system allows for simplified QC monitoring of signals with minimal overlap of active video. The alarm monitoring system allows you to specify alarm parameters that will trigger onscreen and/or remotely monitored warnings when a specified condition is met. This feature provides an unobtrusive QC viewing mode compared to having onscreen scopes active at all times. Please note the alarm monitoring capabilities are limited by the processing power of the monitor. The signal will be sampled at a variable rate depending on other processing loads placed on the monitor. With minimal additional processing demands the fastest sample rate is approximately every 2 to 3 frames. It is therefore possible that an alarm event occurring for only 1 or 2 frames may be missed by the alarm monitoring system. The alarm monitoring system is a useful tool for quick analysis of content to make sure no serious errors exist, but it should not be used as substitute for standalone legalizers and signal level monitoring systems in ultra-critical level monitoring applications.

Alarm

Selects the type of alarm events that will be monitored. This selection **only** affects onscreen (visual) alarms and does not change what alarm events can be monitored through the remote control alarm monitoring software.

Safety Alarm: Will trigger an alarm if a loss of signal is detected, a full black field is detected, a full blue field is detected, and/or embedded audio goes mute for the amount of time specified in the Audio Trigger Time setting. The audio mute alarm will only trigger if audio is being embedded into the signal and is mute for the specified amount of time, there will be no audio mute warning if audio is not being embedded into the SDI signal.

Safety Video Alarm: Same as Safety Alarm minus audio alarms.

IRE Alarm: Will trigger an alarm if the IRE level specified in the IRE Trigger Level setting is exceeded.

RGB Alarm: Will trigger an alarm if any RGB Levels exceed 100 IRE.

IRE & RGB Alarm: Combines IRE and RGB Alarms and will trigger an alarm if either or both exceed their set parameters.

All Alarms: Will trigger an alarm if any alarm condition is met (Loss of Signal, Black Field, Blue Field, Audio Mute, IRE threshold exceeded, RGB levels over 100 IRE).

Visual Alarm

When set to ON a small box will appear on the monitor's screen whenever the alarm condition set in the Alarm menu selection explained above is triggered.



Main Menu	Alarm
Function	Alarm Off
Scopes & Audio Meters	Visual Alarm Off
Video	Remote Alarm Monitoring Off
Audio	IRE Trigger Level 100 IRE
Marker	Audio Trigger Time 3s
Alarm	Audio Phase Indicator Off
OSD	UMD Display UMD
GPI	UMD Color White
Color Management	UMD Position Top
System	Audio Meter Vertical
System Status	Select Alarm Area
Support	

Remote Alarm Monitoring

When set to ON allows for remote alarm monitoring via FSI's remote alarm monitoring software.

IRE Trigger Level

Sets the luminance threshold at which IRE alarms will be triggered, adjustable from 90 to 109 IRE

Audio Trigger Time

Sets the amount of time with mute audio that should elapse before the mute audio alarm is triggered.

Audio Phase Indicator - *Only applies to Safety Broadcast feature*

Enable or disable an Audio Phase Indicator for use with Safety Broadcast.

UMD Display

Only applies to Safety Broadcast feature. Allows you to select whether the Source ID overlay displayed is based on the manually set source ID on the monitor's OSD menu or based on remotely set UMD information over serial connection. You may also turn the selection to off to remove the Source ID overlay.

UMD Color

Only applies to Safety Broadcast feature. Toggles the Source ID text color between White and Black.

UMD Position

Only applies to Safety Broadcast feature. Select top or bottom of screen. Please note that when Timecode Overlay is active the UMD will automatically be positioned at the bottom of the screen.

Audio Meter - *Only applies to Safety Broadcast feature*

Determines horizontal or vertical positioning of Audio Meters in Safety Broadcast.

Select Alarm Area

The screen area monitored for Alarm Triggers can be adjusted using the Select Alarm Area feature. To set the alarm area simply highlight Select Alarm Area and press ENTER. Once active you can use the monitor's rotary knobs to adjust 4 lines on screen, similar to the custom graticules feature on the marker menu, to define the onscreen area that will be monitored. Once your desired area has been set simply use the MENU button to back out of the Select Alarm Area function. The default alarm monitoring area is the whole screen, but this function allows users to specify smaller regions if only a portion of the screen area needs to be monitored.

Main Menu	OSD	
Function	Status Display	5 s
Scopes & Audio Meters	Menu Position	Top Right
Video	Status Position	Top Left
Audio	Rotary Position	Bottom
Marker	Source ID	Off
Alarm	Source ID Position	Bottom
OSD	Source ID Character	CAM1
GPI	Time Code	Off
Color Management	Time Code Size	Small
System	Time Code Position	Top
System Status	Time Code Bg	Translucent Black
Support		

Status Display

Toggles settings for pop up window indicating resolution and frame rate of source when input button is pressed or a new signal type is routed to monitor. Setting this option to Off turns the Status Display function completely off, setting to '5 s' enables a 5 second onscreen status display when the input button is pressed or source format is changed, and setting to On leaves the Status Display onscreen permanently.

Menu Position

Changes position of onscreen menu between three choices: Center, Top Left, or Top Right.

Status Position

Changes position of onscreen status display window. Select from Top Left, Top Right, Bottom Left, Bottom Right, or Center.

Rotary Position

Changes position of onscreen window indicating status of any rotary knob (Volume, Contrast, etc.) during adjustment. Select from Top, Center, or Bottom.

Source ID

Allows you toggle source ID function on/off. The Source ID function can be used to set a manual onscreen label of up to 5 characters. This is often used to allow for the labeling of a monitor as PGM, PVM, CAM, etc. without using placards or tape.

Source ID Position

Changes position of onscreen Source ID function.

Source ID Character

Allows you to customize text for Source ID label using ENTER, UP, and DOWN buttons.

Time Code

Allows you to select whether to display Time Code on screen pulled from an HD/SD-SDI signal. Select between Off, LTC, VITC 1, or VITC 2. Please note that Time Code cannot be displayed at the same time as Scopes, Markers, or other onscreen ancillary functions.

Time Code Size, Position, & Bg

Allows you to toggle between Large or Small Timecode Display, change the onscreen position of timecode, and select translucent black or solid blue background.

Main Menu	GPI	
Function	GPI 1	Red Tally
Scopes & Audio Meters	GPI 2	Green Tally
Video	GPI 3	SDI 1 Input
Audio	GPI 4	SDI 2 Input
Marker	GPI 5	Component Input
Alarm	GPI 6	CVBS Input
OSD	GPI 7	DVI Input
GPI		
Color Management		
System		
System Status		
Support		

NOTE: As of firmware version 9.53-1907 or later you must set the UDisk Mode (System Menu) to OFF in order to use the GPI Contact Closure port for remote control.

This menu allows you to set 7 assignable functions for remote control via the GPI interface on the back of the monitor (RJ-45 connector labeled GPI). Simply select one of the GPI slots, 1 through 7, and press ENTER to generate a list of available functions that can be toggled using the GPI interface.



87654321

When looking at the GPI RJ-45 Connector located on the back of the monitor the pins are arranged 1 through 8 from right to left. This GPI interface is a contact closure based system and PIN 5 is always the ground. The GPI numbering on the GPI menu corresponds to the physical Pin assignments as follows:

Menu	RJ-45 Pin
GPI 1	Pin 1
GPI 2	Pin 2
GPI 3	Pin 3
GPI 4	Pin 4
GPI 5	Pin 6
GPI 6	Pin 7
GPI 7	Pin 8

Menu Locking and Keyboard Locking are features exclusive to the GPI menu. These features allow you to lock just menu access (menu locking), which will still allow functions and rotary knobs to work or to fully lock access by disabling the keypad entirely (keyboard locking). To unlock simply disable the GPI toggle remotely or if using the FSI GPI Keypad Lock, sold separately, simply unplug it from the GPI port.

If using FSI's GPI Keypad Lock to lockout the monitor's keypad or menu the corresponding Keyboard Locking or Menu Locking function must be set to GPI 1.

Main Menu	Color Management	
Function	Color Space	Rec 709
Scopes & Audio Meters	Gamma Select	Gamma 2.4
Video	Color Temperature	6500K
Audio	Color Matching	CIE 1931
Marker	Luminance Mode	Standard Mode
Alarm	Luminance	100
OSD	LUT Bypass	None
GPI	Update LUT	
Color Management	Red Gain	50
System	Green Gain	50
System Status	Blue Gain	50
Support	Red Bias	50
	Green Bias	50
	Blue Bias	50
	Log Mode	Off
	ACES Proxy v1.0.0	Off
	SDI Black Level	Video
	Video Clipping	Off
	Custom Gamma	Off
	SDI Hue Adjustment	Off
	Factory AWB	
	Reset Factory Alignment	

Menus longer than the Main Menu including Video, Color Management, and the System menu will not fully display. These menus will scroll.

Use the Up and Down keys to scroll up and down a menu.

All FSI Monitors are precisely calibrated before shipping with NIST traceable color analyzers specifically setup to measure the model in question. However, if you would manually like to adjust the white balance of the monitor you may do so by using the RGB Gain and Bias adjustment. Please DO NOT use the Reset Factory Alignment or Start Display Alignment functions unless asked to do so by an authorized FSI service representative. A warm-up period of 30 to 60 minutes is advised before making adjustments.

Color Space

BM & CM series monitors are equipped with the FSI CFE2 Color Fidelity Engine and have the ability to work in several different color spaces. Select from available options to instantly change the active color space. Please note that switching to DCI P3 may take up to 10 seconds.

Gamma Select

This setting allows you to specify the desired gamma response of the monitor in 0.2 step increments ranging from a gamma response of 1.8 to 2.8 as well as 2.35 and 1.0. The default gamma setting is 2.4, but any selection may be chosen for instant adjustment of the monitor's gamma response. Older monitor models will override this manual selection in DCI-P3 mode (unless SDI Format is set to XYZ) & operate with a 2.6 gamma response. Attempting to change the value while in DCI-P3 mode will result in the monitor exiting this color space mode, this limitation does not apply on the BM211 & BM241.

Color Temperature

Use this setting to set the desired color temperature. You can instantly toggle between 3200K, 5000K, 5600K, 6500K, and 9300K. 6500K is the default setting. Please note that on older monitor models when selecting the DCI-P3 mode the monitor will override this manual setting. Attempting to select a Color Temperature setting manually with DCI-P3 mode active will result in the monitor exiting DCI-P3 color space mode, this limitation does not apply on the BM211 & BM241.

Color Matching (Alternate CMF Selection for OLED Monitors)

FSI's OLED monitors are capable of operating with calibration based on the standard CIE 1931 Color Matching Function or the Judd Modified CMF, which has largely become the preferred CMF for use with OLEDs. As the Judd Modified CMF is an easy to apply known offset from CIE 1931 for any given display type you can easily toggle between these without having to recalibrate the monitor. This also allows for calibration using software and equipment based on the more common CIE 1931 CMF with the ability to quickly and easily apply the Judd based offset after calibration is complete.

Luminance Mode

Choose from pre-set luminance modes (Standard, Studio, Outdoor) or unlock the luminance slider to customize peak white luminance.

Standard Mode is the default system luminance setting of your monitor as shipped from the factory, nominally 100nits for a new unit.

Studio Mode will set the luminance of a display to approximately 200nits or the maximum attainable luminance of the display, whichever is less. Please note that on several displays, especially OLED units, Studio and Outdoor modes will be effectively the same.

Outdoor Mode will set the luminance of the display to its maximum potential luminance, we only suggest using this mode in very bright environments where combating ambient light levels is a priority. Power consumption and absolute color accuracy can be negatively impacted while in Outdoor Mode.

Custom Mode provides for a very fine tuned customization of monitor peak luminance. Once you select Custom it is necessary to press the MENU button and then re-enter the System Menu for the Luminance slider to become active. On all new units there is roughly a 1 to 1 correspondence between the luminance number shown and the peak luminance as measured in cd/m2 when adjusting the slider between 40 and 120 (e.g. 100 equals roughly 100nits). Above 120 the slider will behave differently depending on the specific monitor type you have and its peak luminance capabilities and characteristics. At a setting of 120 or above older OLED units may visibly jump to max luminance (Outdoor Mode), this is normal and we suggest limiting Custom Mode on OLEDs to a selection between 40 and 120.

Luminance

Adjust peak white luminance when Luminance Mode is set to Custom.

Please note that the Luminance value slider in Custom mode will respond slower if you are in Judd Modified color matching mode on an OLED monitor. If you need to make large changes to the default Luminance slider position it may be faster to first switch to CIE 1931 before adjusting the setting.

LUT Bypass

Used when creating custom LUTs. See Appendix A or B or contact FSI Support for more information about LUT creation.

Update LUT

Used to update LUTs once LUT files have been loaded to the monitor. See Appendix A or B or contact FSI Support for more information about loading LUTs to the monitor.

Red/Green/Blue Gain & Bias

These settings allow you to manually adjust the white balance of the monitor. We suggest using a 100% white field for Gain adjustment and a 30 to 40IRE grey field for Bias adjustment.

Log Mode (Also selectable via Function Buttons)

Allows for easier on-set monitoring of uncorrected of C-Log, S-Log, or BMD Cinema Camera Film Mode Output by roughly normalizing the footage. For all Log modes there is both a Standard and Full selection. The Standard selection is suitable for most applications, but does clip highlights to allow for a brighter overall image. The Full mode is best used for scenes with extremely wide latitude or scenes that are just very bright overall. Full mode preserves the entire native latitude of the signal (nothing is clipped), but this can result in a rather dark image in many applications. We provide both for this reason and you can quickly toggle between them as needed for different applications by assigning these modes to function keys. These modes should only be used to offer on set viewers a rough normalization of the footage to give them an idea of what the content might look like as a starting point in post production. In other words, it provides you with a helpful tool to show on set viewers something that does not look 'flat'.

These Log modes are not a replacement for full 3D LUT transforms and not a substitution for proper color correction in post production applications.

ACES Proxy v1.0.0

Largely deprecated and not commonly used, but kept in firmware for select applications and testing. Provides selection of R709 ODT or DCI P3 ODT for application when monitor is receiving an ACES Proxy signal (v.1.0.0). Please note, ACES Proxy workflows are fairly rare and should not be confused with standard ACES workflows. For typical ACES workflows transforms will be done upstream of the monitor and the monitor simply needs to have its color space and gamma set to match the upstream ODT being used. For example, if the upstream ODT is Rec709/2.4 then the monitor should be set to Color Space: Rec709, Gamma: 2.4 from the Color Management menu. The ACES Proxy toggle is NOT used in such use cases. This point bears repeating: unless you are specifically sending an ACES Proxy signal to the monitor do NOT use this feature.

SDI Black Level

Use this toggle to set the monitor's black level for Video (Legal) range or Data (Full) range. Please ensure that your video signal is setup to match this setting. When set to Video, bit level 16/64 (8 or 10 bit) will be the blackest level on screen. Levels below 16/64 will not be distinguishable from level 16/64. When set to Data, bit level 0/4 will be the blackest level on screen and any levels above this will be distinguishable as brighter levels. Once set to match your video signal path the brightness knob can be used to make subtle adjustments to optimize lowlevel response for your particular viewing environment.

Video Clipping

Setting Video Clipping to On will clip all levels exceeding legal broadcast limits. With Video Clipping on you can see how source content will look if clipped within legal broadcast limits. Setting Video Clipping to Off will show you the full range of levels onscreen, this is the recommended operating mode.

Custom Gamma

Allows a custom 1D LUT for EOTF / Gamma to be activated. Contact FSI support for assistance with generating and loading custom EOTF LUTs. Up to 3 custom user LUTs for EOTF can be uploaded to

SDI Hue Adjustment

This option allows you to activate the HUE (PHASE) adjustment knob while monitoring in SDI. In analog monitoring modes (i.e. Composite Video) the HUE (PHASE) adjustment will always be active. Technically speaking Serial Digital being both a Digital and YCbCr or RGB video format should not require a HUE (PHASE) adjustment, but should you wish to have such an adjustment in SDI you should set this option to On.

Factory AWB

Used at the factory level or with the CA310 DCAA kit. Not used for 3D LUT based calibration with third party calibration software.

Reset Factory Alignment

The password protected Reset Factory Alignment option is for use by FSI and/or authorized FSI service centers only. This option does not reset your monitor to factory default mode, but rather deletes factory calibration data. To reset to factory default mode go to the System Menu, select Load Profile, select Default, and then confirm by pressing enter.

Main Menu	System	
Function	Load Profile	
Scopes & Audio Meters	Save Profile	
Video	Update Firmware	
Audio	Keypad LED	Normal
Marker	Chroma/Bright/Contrast	Unlock
Alarm	Luminance Interval	On
OSD	Udisk Mode	On
GPI	Language	English
Color Management	DHCP	On
System	IP Address	192.168.001.111
System Status	Subnet Mask	255.255.255.0
Support	RS422 Address	1
	Baud Rate	9600
	Parity	None

Load Profile

Recall Saved Profile Settings. Highlight desired profile & press ENTER to activate the saved profile selection.

Save Profile

Saves all current monitor settings under a recallable profile by highlighting Profile number & pressing ENTER.

Update Firmware

As of firmware version 9.53-1907 or later UDisk mode enables your monitor to permanently remain in update mode.

When on you can simply plug your monitor into any compatible computer with the provided USB to RJ-45 update cable and it will be recognized as a USB mass storage device for transfer of new firmware and/or 3D LUTs.

Use this to update firmware once your new firmware file has been loaded to the monitor.

Keypad LED

Allows you to turn off the LED lights on the Monitor's Keypad. Select from Normal, All Off, and All On. In the default Normal mode active keys will illuminate. In All Off mode, no keys will illuminate. In All On mode, all keys will stay illuminated and will flash when activating or deactivating a function.

Chroma/Bright/Contrast

When set to Lock this option will lockout the Chroma, Brightness, & Contrast knobs to help prevent accidental adjustment.

Luminance Interval

The luminance interval is a power saving feature; It allows you to specify the amount of time without an active signal being shown on the monitor that should be allowed to expire before the monitor's backlight (if applicable) is turned off to reduce the power consumption of the unit. When placed in the On position the monitor will not enter the power saving mode and will keep the backlight on so long as the monitor is left on.

UDisk Mode

As of firmware version 9.53-1907 or later you can set this to ON, now the default, to allow your monitor to permanently remain in update mode. When on you can simply plug your monitor into any compatible computer with the provided USB to RJ-45 update cable and it will be recognized as a USB mass storage device for transfer of new firmware and/or LUTs. This should only be turned OFF when using GPI control.

Main Menu	System	
Function	Load Profile	
Scopes & Audio Meters	Save Profile	
Video	Update Firmware	
Audio	Keypad LED	Normal
Marker	Chroma/Bright/Contrast	Unlock
Alarm	Luminance Interval	On
OSD	Udisk Mode	On
GPI	Language	English
Color Management	DHCP	On
System	IP Address	192.168.001.111
System Status	Subnet Mask	255.255.255.0
Support	RS422 Address	1
	Baud Rate	9600
	Parity	None

DHCP

Toggle DHCP On or Off. DHCP allows your monitor to receive an IP address from a DHCP server on your network.

IP Address & Subnet Mask

You can manually configure network settings when DHCP is disabled.

RS422 Address, Baud Rate, & Parity

Set the monitor's RS422 address for remote control and alarm monitoring. Baud Rate should remain at 9600 and Parity at None unless otherwise specified by FSI Support.

Problem	Solution	Notes
Image has a heavy green or magenta cast over DVI	Set DVI Pixel Format selection on System Menu to match your signal format (RGB or YCbCr)	A heavy green cast to the image typically means you are feeding the monitor a YCbCr signal, but have the DVI Pixel Format Selection set to RGB. A heavy Magenta cast to the image typically means you are sending RGB to the monitor, but have DVI Pixel Format set to YCbCr.
Image has a heavy green or magenta cast over SDI	Set SDI Format to match your signal type. This is found at the bottom of the Video Menu.	FSI monitors detect payload ID, if present, and automatically set the monitor to receive RGB, YCbCr, or XYZ signals over SDI. However, if payload ID is missing or corrupt from the source it may be necessary to manually select the SDI format to match your signal type.
Too much video processing delay	<p>On the Video Menu make sure Show PsF as is set to Interlaced. For further reduction in processing delay set Processing to Fast Mode on the Video Menu.</p> <p>Processing speed in all modes is a set interval of the frame rate so the higher your frame rate is the lower your delay will be in milliseconds. For this reason if your camera is capable of independent recording and monitor out frame rates a 50 or 60Hz monitor output will provide the lowest possible delay.</p>	Setting Show PsF as to Progressive, even if the signal is not PsF, adds significant processing delay. Setting this to Interlaced greatly reduces processing delay. Normal Mode processing offers the best balance between ancillary feature speed (e.g. scopes) and video processing speed. Fast Mode can reduce video processing even further, but pulls processing resources away from scopes and other ancillary features so menu artifacts and slower scope update speeds may occur. However, there is no loss in video quality in Fast Mode vs. Normal Mode.
Function button not responding	<p>Reload Default Profile (System Menu -> Load Profile -> Default)</p> <p><i>If you have custom settings selected that you want to retain please make sure to take note of those custom settings or save them to a Profile (1 through 5) for future reference as reloading the default profile will reset all custom settings to factory default.</i></p>	If a function button is not responding it is typically because a conflicting function is active. For example if you set a marker to a function button and enable the marker, then reassign the marker function button to a different feature without turning the marker off first the marker will stay on screen and prevent other functions from being activated. Avoiding such conflicts will prevent the problem or for a quick solution you can reload the default profile to clear the conflict.
Rotary knob not responding	Disable any active functions. To activate the Phase rotary knob in SDI set SDI Hue Adjustment to On from System Menu. Ensure the Lock Chroma/Bright/Contrast setting is set to Off on the System .	The Phase knob is locked by default in SDI as there is no phase to adjust in a digital component signal. Rotary knobs may serve secondary purposes (e.g. Vector Scope Gain) or may be inaccessible with certain functions active.

Problem	Solution	Notes
Progressive signal looks interlaced and/or there are unexpected lines on screen.	Ensure that you are sending the monitor a true progressive signal, not PsF. You can verify whether the signal is PsF or P from the System Status Menu. The monitor will indicate PsF or P accordingly. If PsF is your only output option you can set Show PsF as to Progressive on the Video Menu.	Setting show PsF as to Progressive, instead of interlaced, adds processing delay to the signal so if at all possible feeding the monitor a true progressive signal is preferred.
External audio leads video	Ensure that the 'Show PsF as' option on the Video Menu is set to Interlaced, even if your signal is not PsF. This will greatly reduce video processing delay. Setting Processing to Fast Mode on the Video Menu can further reduce video delay.	You can also use the monitor's audio out to ensure perfect audio/video sync as disembedded audio is always delayed by the exact amount of video processing time.
Image is flickering	On OLED units verify that Flicker Free Mode is turned ON. With all monitors verify the frame rate being received on the System Status menu. If interlaced or PsF the flicker may be normal and part of the signal. Feeding the monitor progressive instead of PsF or setting Show PsF as to Progressive instead of interlaced may further eliminate flicker.	
Image not as sharp as desired	Adjust sharpness level from the Video Menu or use the Max Sharpness function.	No artificial dithering or image enhancement is applied to the image by default.
Scopes refreshing slowly	Displaying 1 scope window instead of 2 will greatly increase scope update speed. Normal update speed with a single scope active is approximately every other frame.	Scope refresh rate is governed by available processing power.
Temporary Image Retention (LCD only)	Image Retention on LCDs typically only occurs when monitoring interlaced footage as interlaced for extended periods of time. If TIR has developed it will automatically begin to dissipate once you send the monitor a progressive signal.	LCD monitors can develop a type of image retention that may be seen as an after image or lines on the screen. This is not burn-in and is not permanent. It typically only occurs with prolonged viewing of interlaced sources as interlaced. The longer an interlaced signal was monitored in Motion Compensated mode the longer it will take for the TIR to disappear, but TIR will always resolve over time provided that a progressive signal is used.

DIT LUTs

As of firmware update 1.0.00-1958, CFE 2 equipped monitors are capable of loading multiple custom DIT / Look LUTs which do not require you to profile the panel. You can use Lattice, LightSpace, or ColourSpace to convert LUTs to FSIs format. The LightSpace workflow is shown below.

Open LightSpace CMS

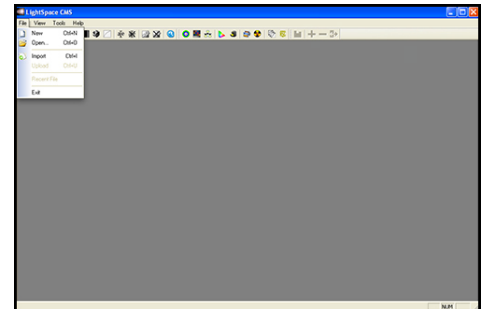

Select File > Import > YourLUT

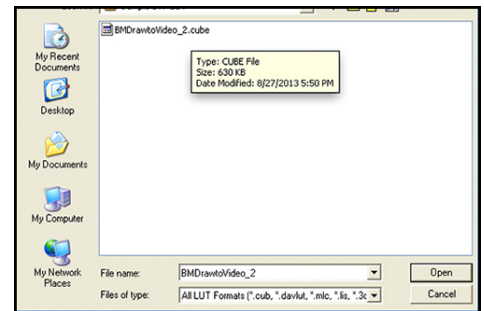

Select File > Export > Choose FS17_32bits (*.dat) as the export format.
In Lattice you should select .dat V2 as the export type.

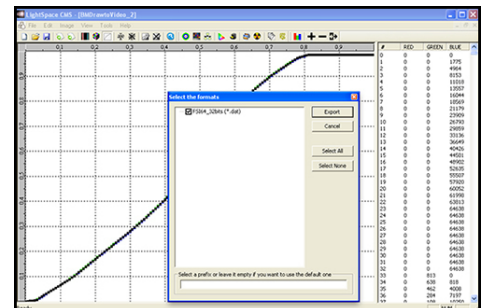

Once the file is saved, change the file name to ditXX.dat where XX is a 2 digit number ranging from 00 to 16. The monitor can store up to 16 DIT LUTs at a time. The naming structure is ditXX.dat with valid LUT names ranging from dit01.dat to dit16.dat.

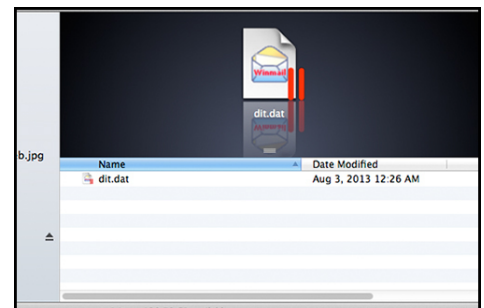

Appendix A - DIT / Look LUTs

Verify that the monitor's update mode is turned on via the System Menu:
System > UDisk Mode > On

System	
Luminance Interval	On
UDisk Mode	On
Language	English

Connect the FSI update cable that came with your monitor (USB to RJ45) to an available USB port on your computer.

After a short time, the computer should recognize the FSI monitor as a mass storage device, viewable in Mac's Finder or PC's My Computer.



Drag and drop the ditXX.dat file(s) you created to the monitor.

All 16 DIT LUTs can be transferred at one time.

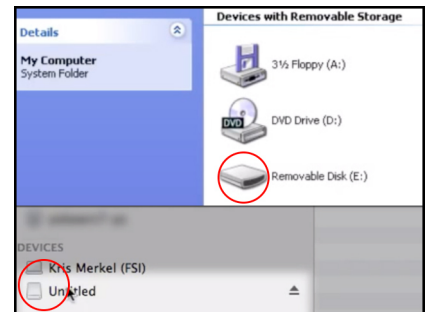

Select Menu > Color Management > Update LUT to save the LUT(s).

Once saved the DIT LUTs can be turned on/off by assigning DIT 3D LUT to a function key.

You can also simply use the up and down arrow keys while the DIT LUT function is active to toggle between 3D DIT LUTs you have loaded to the monitor.

NOTE: When a DIT LUT is active it will impact the Scope and Measurement feature values accordingly to reflect your DIT LUT's impact on the signal. This is in contrast to the simpler Log mode selections found on the Video menu, which will not change scope or measurement values even when active.

Color Management	
Luminance	100
LUT Bypass	None
Update LUT	
Red Gain	50
Green Gain	50
Blue Gain	50

Custom Calibration LUTs

FSI models equipped with FSI's CFE Color Fidelity Engine are capable of loading custom calibration 3D LUTs. This advanced feature requires use of color management software (such as LightIllusion's ColourSpace or Portrait Display's CalMAN, both of which are currently supported) and a professional grade probe. The steps below cover the general process of updating LUTs on the monitor.

Check your monitor's firmware version by accessing System Status from the Main Menu. If necessary, update your FSI CFE equipped monitor to the latest firmware version.

Firmware updates and instructions can be found at FlandersScientific.com.

If you are running firmware version 9.50 or later you can follow the steps outlined below to load a custom calibration LUT to the monitor. For guidance on profiling a monitor with a third party program that outputs LUTs in a compatible FSI LUT format please see the program specific instructions for the solution you are using. The instructions in this manual will only cover pre-profiling setup and how to load a completed 3D LUT to the monitor.

Before profiling, load the default profile on the monitor.

Menu > System > Load Profile > Default

Hit ENTER and confirm with Yes.

System	
Load Profile	
Save Profile	
Update Firmware	
Keypad LED	Normal
Chroma/Bright/Contrast	Unlock
Luminance Interval	On

In the Color Management menu, set LUT Bypass to 3D LUT, effectively placing the monitor in Wide Gamut mode and bypassing the factory 3D LUTs. The monitor should be placed in this mode before profiling with any third party solution.

Color Management	
Luminance	100
LUT Bypass	3D LUT
Update LUT	
Red Gain	50
Green Gain	50
Blue Gain	50

Special Notes for OLED Monitors

We suggest setting the Color Matching Function (Color Management Menu) selection to CIE 1931 for profiling and 3D LUT creation. Once calibration is complete you can switch to Judd modified if you prefer to operate with a Judd modified CMF based calibration.

Once you've generated your custom LUT, You must rename the file saved by the third party program to "user1", "user2", or "user3" if not already named this way before you attempt to import it.

Appendix B - Calibration LUTs

Connect the FSI update cable that came with your monitor (USB to RJ45) to the GPI port on your monitor.

If you misplaced your update cable, they are available from ShopFSI.com.

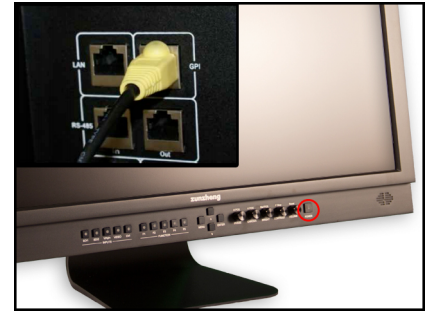

Verify that the monitor's update mode is turned on via the System Menu:
System > UDisk Mode > On

System	
Luminance Interval	On
UDisk Mode	On
Language	English

Connect the FSI update cable that came with your monitor (USB to RJ45) to an available USB port on your computer.

After a short time, the computer should recognize the FSI monitor as a mass storage device, viewable in Mac's Finder or PC's My Computer.



Drag and drop the user1.cfe, user2.cfe, and user3.cfe file(s) you created to the monitor.

All 3 LUTs can be transferred at one time.

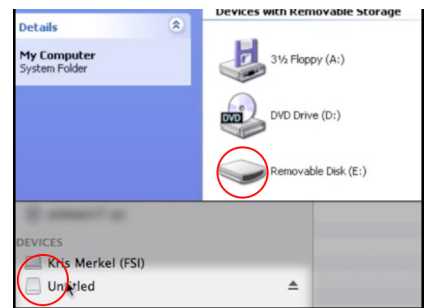

Once the file has finished transferring, on the monitor go to:

Menu > Color Management > Update LUT

Press ENTER to begin the process, and confirm with Yes when the monitor prompts you. The update process will take approximately 6 minutes per LUT on monitors with first generation CFE boards and about 15 seconds per LUT on units with CFE2 boards. Upon completion of the LUT transfer, power cycle the monitor.

Color Management	
Luminance	100
LUT Bypass	3D LUT
Update LUT	
Red Gain	50
Green Gain	50
Blue Gain	50

Once the monitor has rebooted, set LUT Bypass to None.

Menu > Color Management > LUT Bypass

Custom LUTs can be accessed from the Color Management menu by selecting Color Space: USER1, USER2, USER3. Press ENTER to confirm your selection.

Color Management	
Luminance	100
LUT Bypass	None
Update LUT	

BM & CM Series Monitors have basic remote control functionality available over ethernet.

Connecting to a Network

To connect a BM or CM Series Monitor to a network connect an ethernet cable to the monitor's LAN port.

DHCP Settings

BM & CM Series Monitors are DHCP compatible and will obtain an IP address from your network. You can view the monitor's IP address in the System Status menu. DHCP can be set to OFF in the System menu, allowing you to assign a static IP address and subnet mask.

Note: When changing static IP addresses, you must power cycle the monitor to set the new IP address.

Direct Connection

BM & CM Series Monitors can also be connected directly to your PC or Mac via ethernet connection. To directly connect you must assign static IP addresses to your monitor and to your computer using the same subnet mask. The IP addresses must be different for each device.

When connecting directly, you should disable other network connections (including WiFi) on your computer.

Suggested Settings:

Computer IP: 192.168.001.002

Subnet Mask on Computer and Monitor: 255.255.255.0

Monitor IP: 192.168.001.003

Gateway IP setting on monitor: 192.168.001.001

Note: When changing static IP addresses, you must power cycle the monitor to set the new IP address. If the monitor fails to obtain an IP address or disconnects, try toggling DHCP On and Off to reset the network settings.

Remote Control

BM & CM Series Monitors can be controlled remotely using FSI's IP Remote Utility, available free at FlandersScientific.com.

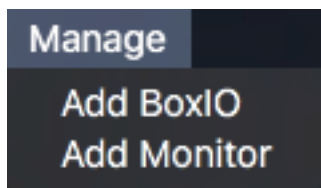

From the Manage menu, select "Add Monitor" to add a monitor control tab to your IPRU window.

Enter the IP address of the monitor you would like to control in the IP Address field and press connect.

You can control multiple monitors or BoxIO by adding additional tabs.

